

# Automatic Door Products

## Product List



Door Packages  
Mats and Trim  
Guide Rails/Posts  
Push Plate Switches  
Receivers & Transmitters  
Finger Guards



## Table of Contents

Automatic Door Activation Packages.....	3
Mat Options.....	25
Aluminum Mat Trim.....	31
Guide Rails/Posts.....	49
Push Plate Switches.....	55
Receivers & Transmitters.....	67
Finger Guards.....	68

# Automatic Door Activation Packages

## One-Stop Automatic Door Activation & Safety Systems

Larco has taken the guesswork out of selecting the safest door-activation device on the market by offering automatic door entrance/exit packages to accommodate any automatic door style, making it even easier to order automatic door activation and safety systems.

The activation packages, which are designed to accommodate sliding doors, folding doors and swing doors, include everything necessary for a safe, reliable installation. Presence-sensing mats, trim, threshold and guide rails are all listed under one convenient number and designed to comply with the current ANSI/BHMA A156.10 standard. Larco door activation packages come installation-ready with all necessary mounting hardware and installation instructions. There are no pre-installation adjustments, which makes installation a snap.

Utilizing proven technology and advancements in materials and methods, Larco presence-sensing mats have evolved to withstand extreme conditions for total safety and reliability without adjustments or maintenance.

Larco, the industry leader in presence-sensing mat technology, makes it simple to meet current ANSI/BHMA A156.10 standards by introducing individual activation and safety mat packages...One Part Number, One Price...Easy as 1,2,3!

### What do I need to Know Before I Order?

Answer three simple questions and you can easily choose the package that is best suited for your application. Each Larco door control package has been assembled based on the style of door selected, the traffic pattern anticipated and the width of the door's opening.

- 1 What Type of Door will be Installed?**  
Swinging (Single or Simultaneous Pair), Sliding (Single or Bi-Part Slide) or Folding (Single or Bi-Fold)
- 2 What is the Anticipated Traffic Pattern?**  
Will the pedestrian traffic exit only (one way), enter only (one way) or will the traffic enter and exit through the same door (two way)?
- 3 What is the Width of the Door's Opening?**  
ANSI/BHMA A156.10 defines "door opening" differently depending on the door type selected. Find the definition to the right that best fits your application:

#### Single Swing Doors:

With the door open 90 degrees, the door opening is measured from the face of the open door to door jamb or jamb stop, if present.

#### Pair of Swing Doors:

With the doors open 90 degrees, the door opening is measured between the faces of the two open doors.

#### Single Sliding or Folding Doors:

With the door in the fully open position, the door opening is measured from the leading edge of the stile to the door jamb or jamb stop, if present.

#### Bi-Part Sliding or Bi-Fold Doors:

With the doors in the fully open position, the door opening is measured between the edges of the leading stiles of the two doors.

With your answers in hand, selecting the safest activation package on the market becomes fast and simple. Use page 4 as a guide to selecting your package.

# Automatic Door Activation Packages

## One-Stop Automatic Door Activation & Safety Systems

### Door Package Overview

DOOR TYPE	TRAFFIC PATTERN	DOOR OPENING	PACKAGE NUMBER	DETAILS PAGE
<b>SINGLE SWING DOORS</b>				
Mats Used for Both Activation & Safety	One-way	36" - 48"	SW01	5
	Two-way		SW02	6
Mats Used for Safety Only*	One-way	36" - 48"	SW03	7
	Two-way		SW04	8
<b>SIMULTANEOUS SWING DOORS</b>				
Mats Used for Both Activation & Safety	One-way	48" - 84"	SP01	9
	Two-way		SP02	10
Mats Used for Safety Only*	One-way	48" - 84"	SP03	11
	Two-way		SP04	12
<b>SINGLE SLIDE DOORS</b>				
Mats Used for Both Activation & Safety	One-way	36" - 48"	SS01	13
	Two-way		SS02	14
<b>BI-PART SLIDE DOORS</b>				
Mats Used for Both Activation & Safety	One-way	48" - 96"	BP01	15
	Two-way		BP02	16
<b>SINGLE-FOLD DOORS</b>				
Mats Used for Both Activation & Safety	One-way	36" - 48"	SF01	17
	Two-way		SF02	18
Mats Used for Safety Only*	One-way	36" - 48"	SF03	19
	Two-way		SF04	20
<b>BI-FOLD DOORS</b>				
Mats Used for Both Activation & Safety	One-way	60" - 96"	BF01	21
	Two-way		BF02	22
Mats Used for Safety Only*	One-way	60" - 96"	BF03	23
	Two-way		BF04	24

### Door Package Optional Accessories

Although not required for ANSI compliance, you can enhance your entrance with glass guards or push bars.

You can also customize your guide rails with bronze finish for an additional cost. Contact us for details on this option.

In addition, you can specify mat monograms, arrows, informational messages, greetings, special surfaces (including the Larco SureStep non-skid surface) and anodized trim to customize your installation. For more information on these options contact us.

Safety mat monitoring is required by the ANSI/BHMA A156.10 Standard for Power Operated Pedestrian Doors. Ask us how you can install our Mat Monitor along with your new automatic door safety mat.

\* The recommended installation includes mats on both sides of the doors. In packages where mats are used on the safety side only, another activation method must be used. In this configuration, the door's closing cycle must have a delay of 4 seconds after the activating area is clear.



### Single Swing Doors

#### Mats Used for Both Activation & Safety – One Way Traffic

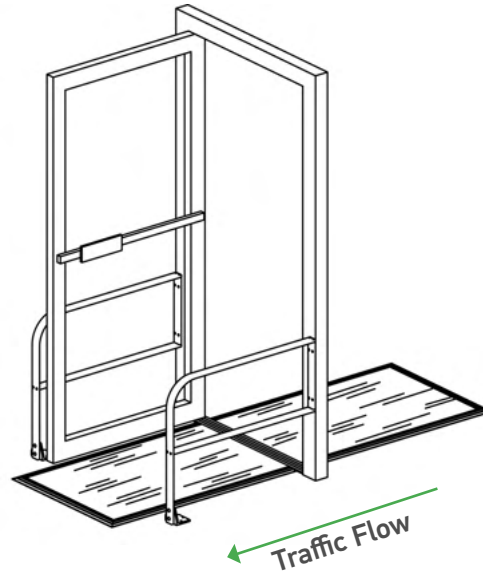
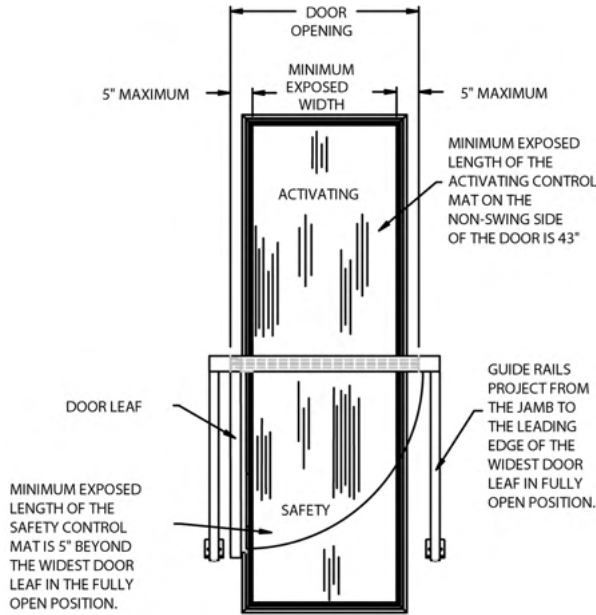

PACKAGE DESCRIPTION	QUANTITY	DOOR OPENING
<b>PACKAGE SW01-36</b>		
27-1/2" x 44" Black Mat with Coarse Ribs and Lock Lip Edge	2	Up to 36"
3-sided Trim Kit with 2" Ramp Trim (Die #3311)	2	
Threshold Assembly (Die #200)	1	
30" x 42" Standard Floor to Wall Double Guide Rails (clear finish)	2	
<b>PACKAGE SW01-42</b>		
34-7/8" x 43-3/16" Black Mat with Coarse Ribs and Lock Lip Edge	1	Up to 42"
34-7/8" x 55-3/16" Black Mat with Coarse Ribs and Lock Lip Edge	1	
3-sided Trim Kit with 2" Ramp Trim (Die #3311)	2	
Threshold Assembly (Die #200)	1	
30" x 48" Standard Floor to Wall Double Guide Rails (clear finish)	2	
<b>PACKAGE SW01-48</b>		
39-1/2" x 44" Black Mat with Coarse Ribs and Lock Lip Edge	1	Up to 48"
39-1/2" x 56" Black Mat with Coarse Ribs and Lock Lip Edge	1	
3-sided Trim Kit with 2" Ramp Trim (Die #3311)	2	
Threshold Assembly (Die #200)	1	
30" x 48" Standard Floor to Wall Double Guide Rails (clear finish)	2	

## Single Swing Doors

### Mats Used for Both Activation & Safety – Two Way Traffic

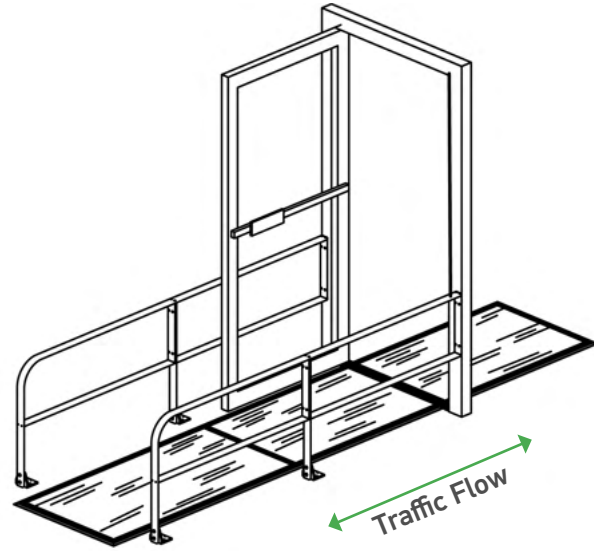
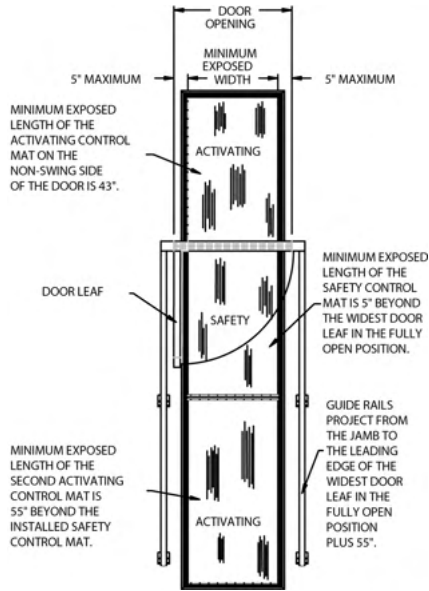

PACKAGE DESCRIPTION	QUANTITY	DOOR OPENING
<b>PACKAGE SW02-36</b>		
27-1/2" x 44" Black Mat with Coarse Ribs and Lock Lip Edge	2	Up to 36"
27-1/2" x 56" Black Mat with Coarse Ribs and Lock Lip Edge	1	
3-sided Trim Kit with 2" Ramp Trim (Die #3311)	1	
3-sided Trim Kit with 2" Ramp Trim and Joining Trim (Die #3311 & 2705)	1	
Threshold Assembly (Die #200)	1	
30" x 96" Standard Floor to Wall Double Guide Rails (clear finish)	2	
<b>PACKAGE SW02-42</b>		
34-7/8" x 43-3/16" Black Mat with Coarse Ribs and Lock Lip Edge	1	Up to 42"
34-7/8" x 55-3/16" Black Mat with Coarse Ribs and Lock Lip Edge	2	
3-sided Trim Kit with 2" Ramp Trim (Die #3311)	1	
3-sided Trim Kit with 2" Ramp Trim and Joining Trim (Die #3311 & 2705)	1	
Threshold Assembly (Die #200)	1	
30" x 104" Standard Floor to Wall Double Guide Rails (clear finish)	2	
<b>PACKAGE SW02-48</b>		
39-1/2" x 44" Black Mat with Coarse Ribs and Lock Lip Edge	1	Up to 48"
39-1/2" x 56" Black Mat with Coarse Ribs and Lock Lip Edge	2	
3-sided Trim Kit with 2" Ramp Trim (Die #3311)	1	
3-sided Trim Kit with 2" Ramp Trim and Joining Trim (Die #3311 & 2705)	1	
Threshold Assembly (Die #200)	1	
30" x 104" Standard Floor to Wall Double Guide Rails (clear finish)	2	

## Single Swing Doors Mats Used for Safety Only – One Way Traffic

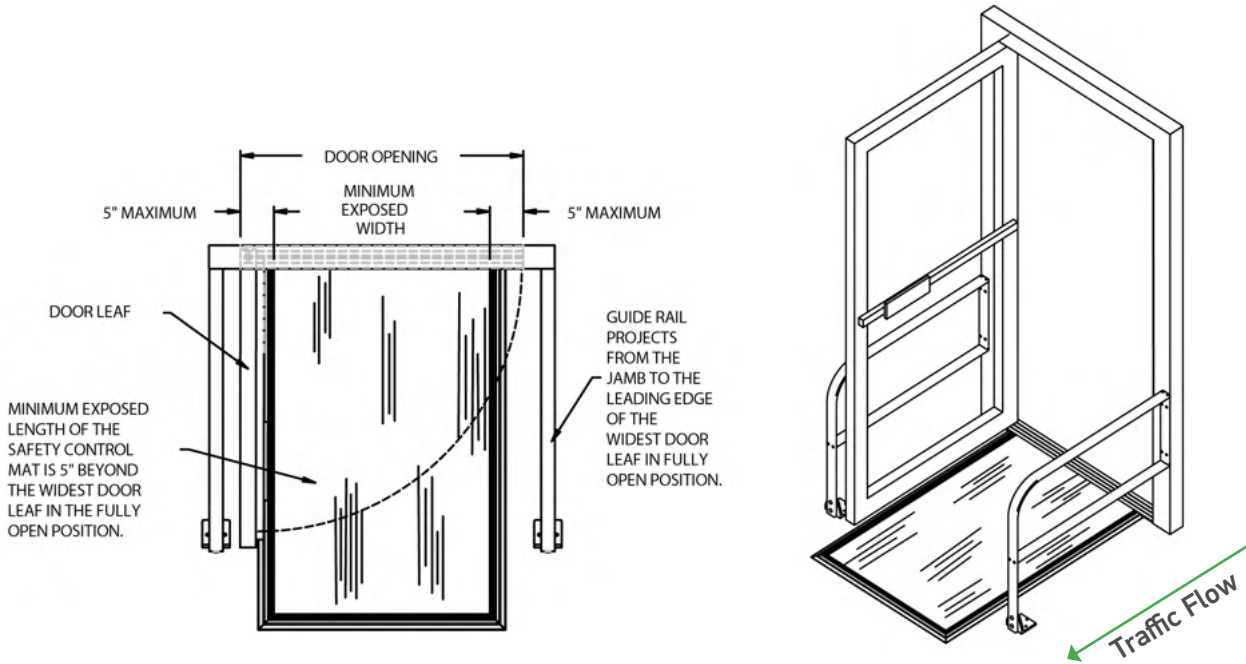

\* Larco recommends presence-sensing mats for both activation and safety for all types of swinging doors. We also recognize that presence-sensing mats may not be suitable for every application and circumstance. For those occasions when a sensor will be used for the entry on the approach side of a door, Larco recommends using presence-sensing mats for safety on the swing side of the door. Additional requirements may apply depending on the type of sensor used. Refer to ANSI A156.10 Standard for Power Operated Pedestrian doors for additional guidance.

PACKAGE DESCRIPTION	QUANTITY	DOOR OPENING
<b>PACKAGE SW03-36</b>		Up to 36"
27-1/2" x 44" Black Mat with Coarse Ribs and Lock Lip Edge	1	
3-sided Trim Kit with 2" Ramp Trim (Die #3311)	1	
Threshold Kit (Die #1250 & 200)	1	
30" x 42" Standard Floor to Wall Double Guide Rails (clear finish)	2	
<b>PACKAGE SW03-42</b>		Up to 42"
34-7/8" x 55-3/16" Black Mat with Coarse Ribs and Lock Lip Edge	1	
3-sided Trim Kit with 2" Ramp Trim (Die #3311)	1	
Threshold Kit (Die #1250 & 200)	1	
30" x 48" Standard Floor to Wall Double Guide Rails (clear finish)	2	
<b>PACKAGE SW03-48</b>		Up to 48"
39-1/2" x 56" Black Mat with Coarse Ribs and Lock Lip Edge	1	
3-sided Trim Kit with 2" Ramp Trim (Die #3311)	1	
Threshold Kit (Die #1250 & 200)	1	
30" x 48" Standard Floor to Wall Double Guide Rails (clear finish)	2	

## Single Swing Doors Mats Used for Swing Side Only – Two Way Traffic

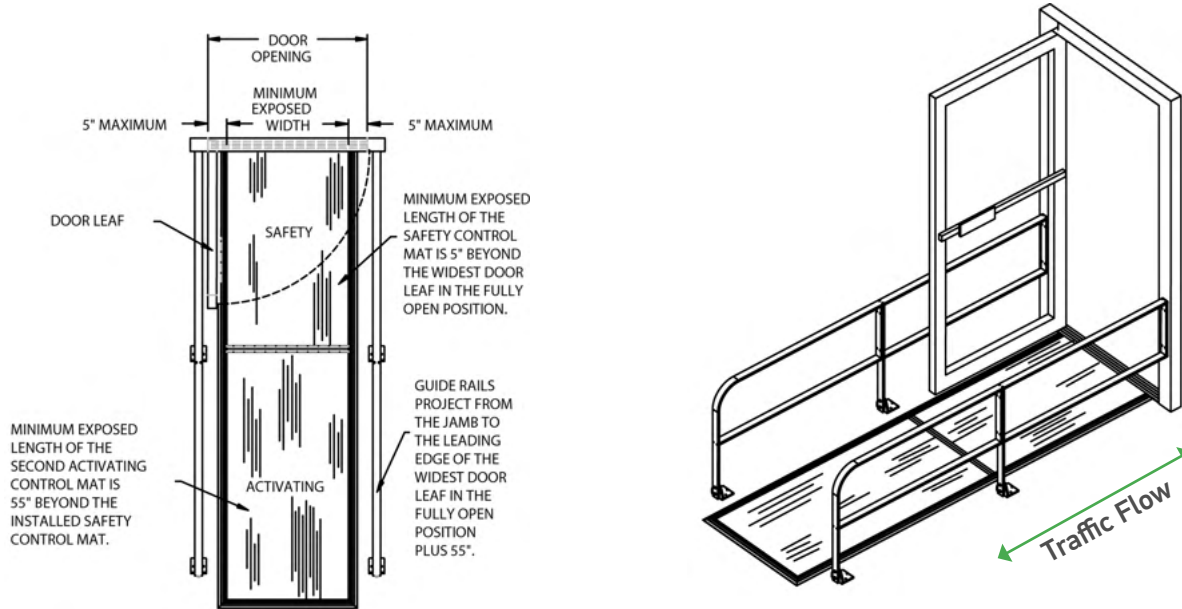

\* Larco recommends presence-sensing mats for both activation and safety for all types of swinging doors. We also recognize that presence-sensing mats may not be suitable for every application and circumstance. For those occasions when a sensor will be used for the entry on the approach side of a door, Larco recommends using presence-sensing mats for safety on the swing side of the door. Additional requirements may apply depending on the type of sensor used. Refer to ANSI A156.10 Standard for Power Operated Pedestrian doors for additional guidance.

PACKAGE DESCRIPTION	QUANTITY	DOOR OPENING
<b>PACKAGE SW04-36</b>		
27-1/2" x 56" Black Mat with Coarse Ribs and Lock Lip Edge	1	Up to 36"
27-1/2" x 44" Black Mat with Coarse Ribs and Lock Lip Edge	1	
3-sided Trim Kit with 2" Ramp Trim and Joining Trim (Die #3311 & 2705)	1	
Threshold Kit (Die #1250 & 200)	1	
30" x 96" Standard Floor to Wall Double Guide Rails (clear finish)	2	
<b>PACKAGE SW04-42</b>		
34-7/8" x 55-3/16" Black Mat with Coarse Ribs and Lock Lip Edge	2	Up to 42"
3-sided Trim Kit with 2" Ramp Trim and Joining Trim (Die #3311 & 2705)	1	
Threshold Kit (Die #1250 & 200)	1	
30" x 104" Standard Floor to Wall Double Guide Rails (clear finish)	2	
<b>PACKAGE SW04-48</b>		
39-1/2" x 56" Black Mat with Coarse Ribs and Lock Lip Edge	2	Up to 48"
3-sided Trim Kit with 2" Ramp Trim and Joining Trim (Die #3311 & 2705)	1	
Threshold Kit (Die #1250 & 200)	1	
30" x 108" Standard Floor to Wall Double Guide Rails (clear finish)	2	

### Simultaneous Swing Doors

#### Mats Used for Both Activation & Safety – One Way Traffic

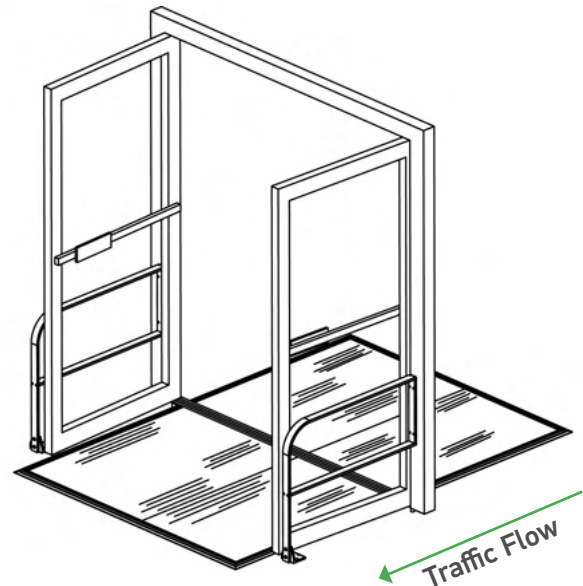
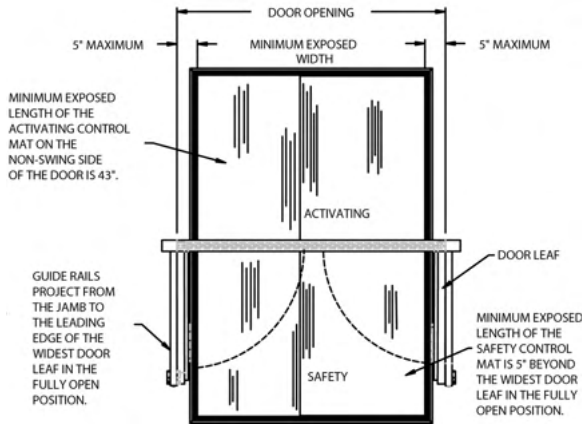

PACKAGE DESCRIPTION	QUANTITY	DOOR OPENING
<b>PACKAGE SP01-48</b>		
40-7/8" x 43-3/16" Black Mat with Coarse Ribs and Lock Lip Edge	2	Up to 48"
3-sided Trim Kit with 2" Ramp Trim (Die #3311)	2	
Threshold Assembly (Die #200)	1	
30" x 36" Standard Floor to Wall Double Guide Rails (clear finish)	2	
<b>PACKAGE SP01-60</b>		
27-1/2" x 43" Black Mat with Coarse Ribs and Lock Lip Edge	4	Up to 60"
3-sided Trim Kit with 2" Ramp Trim (Die #3311)	2	
Threshold Assembly (Die #200)	1	
30" x 42" Standard Floor to Wall Double Guide Rails (clear finish)	2	
<b>PACKAGE SP01-72</b>		
33-1/2" x 44" Black Mat with Coarse Ribs and Lock Lip Edge	4	Up to 72"
3-sided Trim Kit with 2" Ramp Trim (Die #3311)	2	
Threshold Assembly (Die #200)	1	
30" x 42" Standard Floor to Wall Double Guide Rails (clear finish)	2	
<b>PACKAGE SP01-84</b>		
39-1/2" x 44" Black Mat with Coarse Ribs and Lock Lip Edge	2	Up to 84"
39-1/2" x 56" Black Mat with Coarse Ribs and Lock Lip Edge	2	
3-sided Trim Kit with 2" Ramp Trim (Die #3311)	2	
Threshold Assembly (Die #200)	1	
30" x 48" Standard Floor to Wall Double Guide Rails (clear finish)	2	

## Simultaneous Swing Doors Mats Used for Swing Side Only – Two Way Traffic

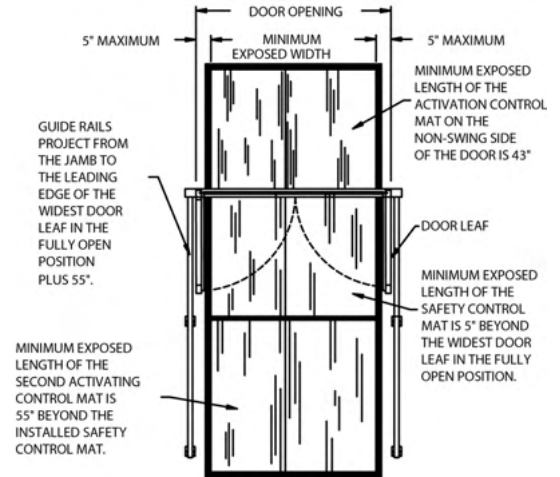
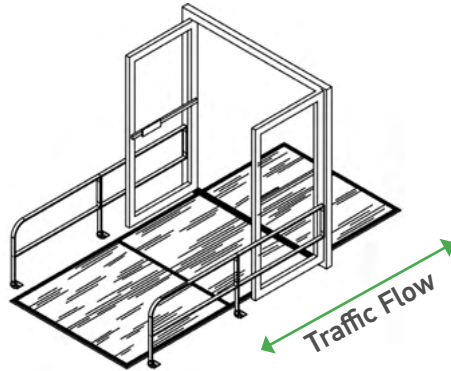

PACKAGE DESCRIPTION	QUANTITY	DOOR OPENING
<b>PACKAGE SP02-48</b>		
40-7/8" x 31-3/16" Black Mat with Coarse Ribs and Lock Lip Edge	1	Up to 48"
40-7/8" x 43-3/16" Black Mat with Coarse Ribs and Lock Lip Edge	1	
40-7/8" x 55-3/16" Black Mat with Coarse Ribs and Lock Lip Edge	1	
3-sided Trim Kit with 2" Ramp Trim (Die #3311)	1	
3-sided Trim Kit with 2" Ramp Trim and Joining Trim (Die #3311 & 2705)	1	
Threshold Assembly (Die #200)	1	
30" x 80" Standard Floor to Wall Double Guide Rails (clear finish)	2	
<b>PACKAGE SP02-60</b>		
27-1/2" x 44" Black Mat with Coarse Ribs and Lock Lip Edge	4	Up to 60"
27-1/2" x 56" Black Mat with Coarse Ribs and Lock Lip Edge	2	
3-sided Trim Kit with 2" Ramp Trim (Die #3311)	1	
3-sided Trim Kit with 2" Ramp Trim and Joining Trim (Die #3311 & 2705)	1	
Threshold Assembly (Die #200)	1	
30" x 86" Standard Floor to Wall Double Guide Rails (clear finish)	2	
<b>PACKAGE SP02-72</b>		
33-1/2" x 44" Black Mat with Coarse Ribs and Lock Lip Edge	4	Up to 72"
33-1/2" x 56" Black Mat with Coarse Ribs and Lock Lip Edge	2	
3-sided Trim Kit with 2" Ramp Trim (Die #3311)	1	
3-sided Trim Kit with 2" Ramp Trim and Joining Trim (Die #3311 & 2705)	1	
Threshold Assembly (Die #200)	1	
30" x 96" Standard Floor to Wall Double Guide Rails (clear finish)	2	
<b>PACKAGE SP02-84</b>		
39-1/2" x 44" Black Mat with Coarse Ribs and Lock Lip Edge	2	Up to 84"
39-1/2" x 56" Black Mat with Coarse Ribs and Lock Lip Edge	4	
3-sided Trim Kit with 2" Ramp Trim (Die #3311)	1	
3-sided Trim Kit with 2" Ramp Trim and Joining Trim (Die #3311 & 2705)	1	
Threshold Assembly (Die #200)	1	
30" x 98" Standard Floor to Wall Double Guide Rails (clear finish)	2	



### Simultaneous Swing Doors Mats Used for Safety Only – One Way Traffic

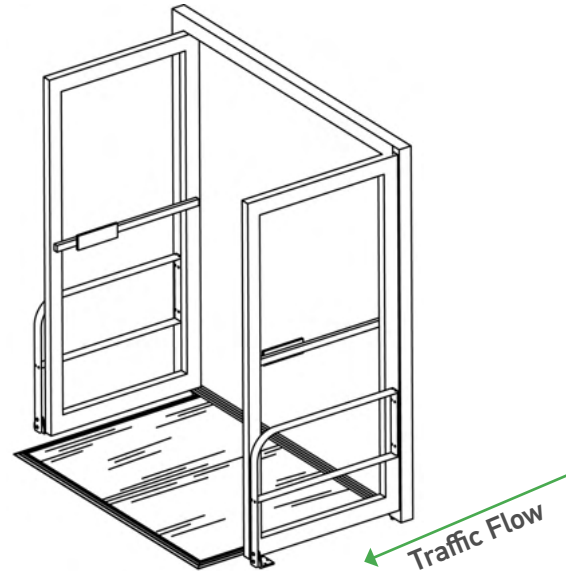
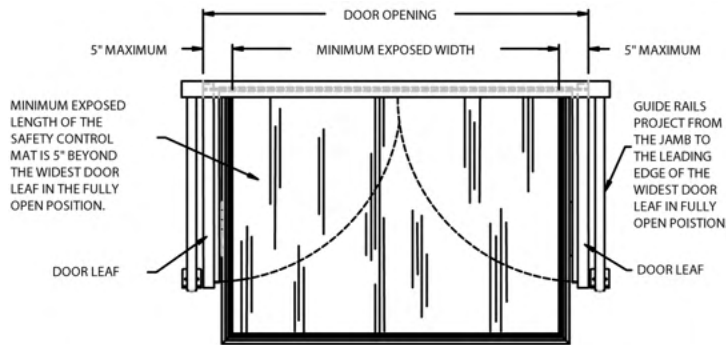

\* Larco recommends presence-sensing mats for both activation and safety for all types of swinging doors. We also recognize that presence-sensing mats may not be suitable for every application and circumstance. For those occasions when a sensor will be used for the entry on the approach side of a door, Larco recommends using presence-sensing mats for safety on the swing side of the door. Additional requirements may apply depending on the type of sensor used. Refer to ANSI A156.10 Standard for Power Operated Pedestrian doors for additional guidance.

PACKAGE DESCRIPTION	QUANTITY	DOOR OPENING
<b>PACKAGE SP03-48</b>		
40-7/8" x 43-3/16" Black Mat with Coarse Ribs and Lock Lip Edge	1	Up to 48"
3-sided Trim Kit with 2" Ramp Trim (Die #3311)	1	
Threshold Kit (Die #1250 & 200)	1	
30" x 36" Standard Floor to Wall Double Guide Rails (clear finish)	2	
<b>PACKAGE SP03-60</b>		
27-1/2" x 43" Black Mat with Coarse Ribs and Lock Lip Edge	2	Up to 60"
3-sided Trim Kit with 2" Ramp Trim (Die #3311)	1	
Threshold Kit (Die #1250 & 200)	1	
30" x 36" Standard Floor to Wall Double Guide Rails (clear finish)	2	
<b>PACKAGE SP03-72</b>		
33-1/2" x 44" Black Mat with Coarse Ribs and Lock Lip Edge	2	Up to 72"
3-sided Trim Kit with 2" Ramp Trim (Die #3311)	1	
Threshold Kit (Die #1250 & 200)	1	
30" x 42" Standard Floor to Wall Double Guide Rails (clear finish)	2	
<b>PACKAGE SP03-84</b>		
39-1/2" x 56" Black Mat with Coarse Ribs and Lock Lip Edge	2	Up to 84"
3-sided Trim Kit with 2" Ramp Trim (Die #3311)	1	
Threshold Kit (Die #1250 & 200)	1	
30" x 48" Standard Floor to Wall Double Guide Rails (clear finish)	2	



## Simultaneous Swing Doors Mats Used on Safety Side Only – Two Way Traffic

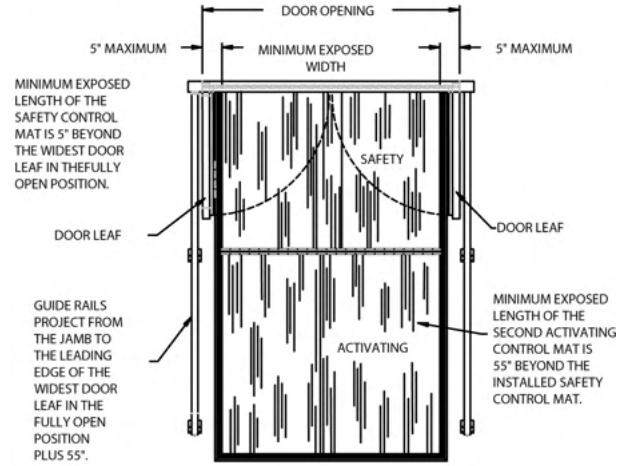
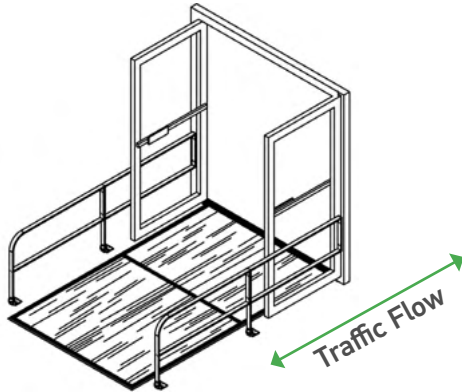

\* Larco recommends presence-sensing mats for both activation and safety for all types of swinging doors. We also recognize that presence-sensing mats may not be suitable for every application and circumstance. For those occasions when a sensor will be used for the entry on the approach side of a door, Larco recommends using presence-sensing mats for safety on the swing side of the door. Additional requirements may apply depending on the type of sensor used. Refer to ANSI A156.10 Standard for Power Operated Pedestrian doors for additional guidance.

PACKAGE DESCRIPTION	QUANTITY	DOOR OPENING
<b>PACKAGE SP04-48</b>		
40-7/8" x 43-3/16" Black Mat with Coarse Ribs and Lock Lip Edge	1	Up to 48"
40-7/8" x 55-3/16" Black Mat with Coarse Ribs and Lock Lip Edge	1	
3-sided Trim Kit with 2" Ramp Trim and Joining Trim (Die #3311 & 2705)	1	
Threshold Kit (Die #1250 & 200)	1	
30" x 80" Standard Floor to Wall Double Guide Rails (clear finish)	2	
<b>PACKAGE SP04-60</b>		
27-1/2" x 44" Black Mat with Coarse Ribs and Lock Lip Edge	2	Up to 60"
27-1/2" x 56" Black Mat with Coarse Ribs and Lock Lip Edge	2	
3-sided Trim Kit with 2" Ramp Trim and Joining Trim (Die #3311 & 2705)	1	
Threshold Kit (Die #1250 & 200)	1	
30" x 86" Standard Floor to Wall Double Guide Rails (clear finish)	2	
<b>PACKAGE SP04-72</b>		
33-1/2" x 56" Black Mat with Coarse Ribs and Lock Lip Edge	2	Up to 72"
33-1/2" x 44" Black Mat with Coarse Ribs and Lock Lip Edge	2	
3-sided Trim Kit with 2" Ramp Trim and Joining Trim (Die #3311 & 2705)	1	
Threshold Kit (Die #1250 & 200)	1	
30" x 96" Standard Floor to Wall Double Guide Rails (clear finish)	2	
<b>PACKAGE SP04-84</b>		
39-1/2" x 56" Black Mat with Coarse Ribs and Lock Lip Edge	4	Up to 84"
3-sided Trim Kit with 2" Ramp Trim and Joining Trim (Die #3311 & 2705)	1	
Threshold Kit (Die #1250 & 200)	1	
30" x 104" Standard Floor to Wall Double Guide Rails (clear finish)	2	

### Single Slide Doors

#### Mats Used for Both Activation & Safety – One Way Traffic

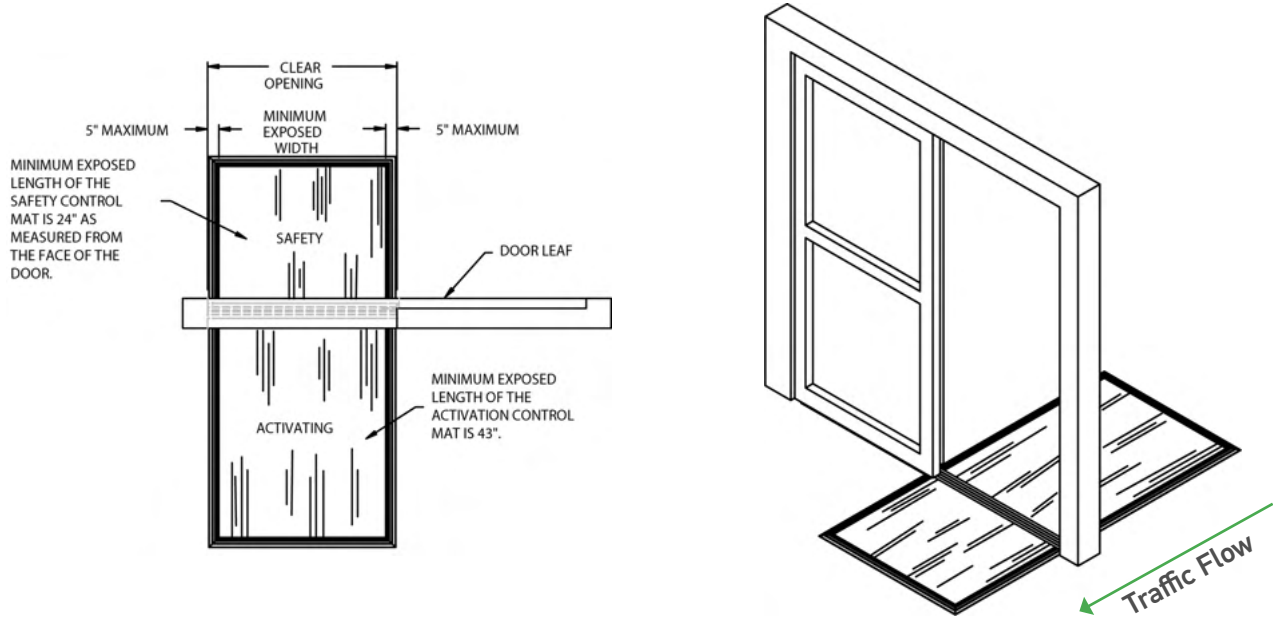

PACKAGE DESCRIPTION	QUANTITY	DOOR OPENING
<b>PACKAGE SS01-36</b>		
27-1/2" x 44" Black Mat with Coarse Ribs and Lock Lip Edge	1	Up to 36"
Black Mat with Coarse Ribs and Lock Lip Edge	1	
3-sided Trim Kit with 2" Ramp Trim (Die #3311)	2	
Threshold Assembly (Die #200)	1	
<b>PACKAGE SS01-42</b>		
34-7/8" x 43-3/16" Black Mat with Coarse Ribs and Lock Lip Edge	1	Up to 42"
34-7/8" x 31-3/16" Black Mat with Coarse Ribs and Lock Lip Edge	1	
3-sided Trim Kit with 2" Ramp Trim (Die #3311)	2	
Threshold Assembly (Die #200)	1	
<b>PACKAGE SS01-48</b>		
40-7/8" x 43-3/16" Black Mat with Coarse Ribs and Lock Lip Edge	1	Up to 48"
40-7/8" x 31-3/16" Black Mat with Coarse Ribs and Lock Lip Edge	1	
3-sided Trim Kit with 2" Ramp Trim (Die #3311)	2	
Threshold Assembly (Die #200)	1	

## Single Slide Door Activation Mats Used for Both Activation & Safety – Two Way Traffic

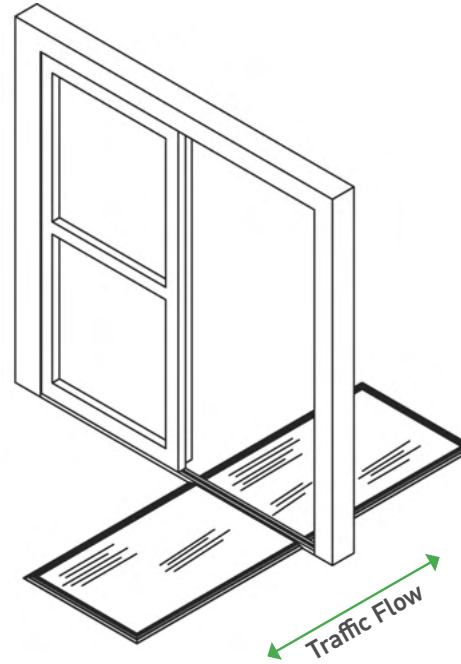
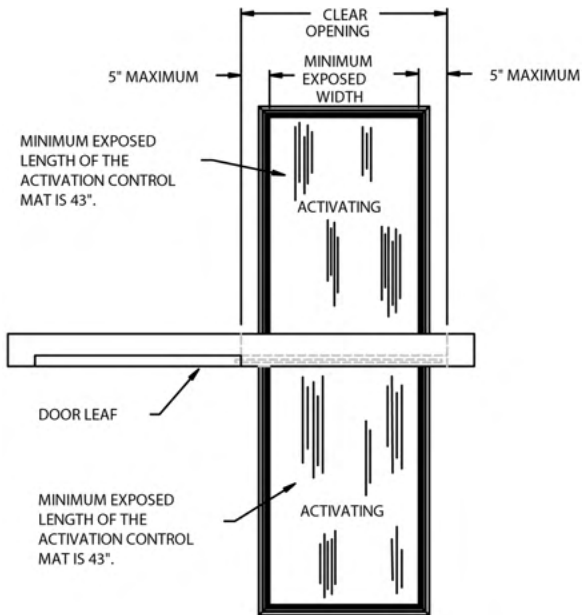

PACKAGE DESCRIPTION	QUANTITY	DOOR OPENING
<b>PACKAGE SS02-36</b>		
27-1/2" x 44" Black Mat with Coarse Ribs and Lock Lip Edge	2	Up to 36"
3-sided Trim Kit with 2" Ramp Trim (Die #3311)	2	
Threshold Assembly (Die #200)	1	
<b>PACKAGE SS02-42</b>		
34-7/8" x 43-3/16" Black Mat with Coarse Ribs and Lock Lip Edge	2	Up to 42"
3-sided Trim Kit with 2" Ramp Trim (Die #3311)	2	
Threshold Assembly (Die #200)	1	
<b>PACKAGE SS02-48</b>		
39-1/2" x 44" Black Mat with Coarse Ribs and Lock Lip Edge	2	Up to 48"
3-sided Trim Kit with 2" Ramp Trim (Die #3311)	2	
Threshold Assembly (Die #200)	1	

### Bi-Part Slide Doors

#### Mats Used for Both Activation & Safety – One Way Traffic

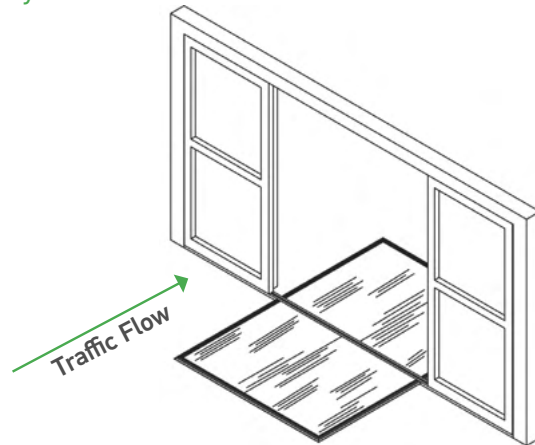
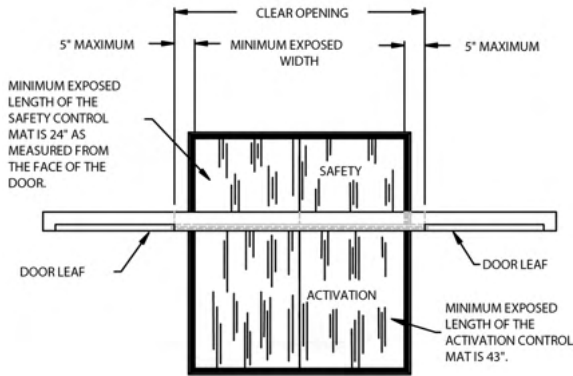

PACKAGE DESCRIPTION	QUANTITY	DOOR OPENING
<b>PACKAGE BP01-48</b>		
40-7/8" x 43-3/16" Black Mat with Coarse Ribs and Lock Lip Edge	1	Up to 48" Clear Opening
40-7/8" x 31-3/16" Black Mat with Coarse Ribs and Lock Lip Edge	1	
3-sided Trim Kit with 2" Ramp Trim (Die #3311)	2	
Threshold Assembly (Die #200)	1	
<b>PACKAGE BP01-60</b>		
27-1/2" x 44" Black Mat with Coarse Ribs and Lock Lip Edge	2	Up to 60" Clear Opening
27-1/2" x 27-1/2" Black Mat with Coarse Ribs and Lock Lip Edge	2	
3-sided Trim Kit with 2" Ramp Trim (Die #3311)	2	
Threshold Assembly (Die #200)	1	
<b>PACKAGE BP01-72</b>		
33-1/2" x 44" Black Mat with Coarse Ribs and Lock Lip Edge	2	Up to 72" Clear Opening
33-1/2" x 32" Black Mat with Coarse Ribs and Lock Lip Edge	2	
3-sided Trim Kit with 2" Ramp Trim (Die #3311)	2	
Threshold Assembly (Die #200)	1	
<b>PACKAGE BP01-84</b>		
40-7/8" x 43-3/16" Black Mat with Coarse Ribs and Lock Lip Edge	2	Up to 84" Clear Opening
40-7/8" x 31-3/16" Black Mat with Coarse Ribs and Lock Lip Edge	2	
3-sided Trim Kit with 2" Ramp Trim (Die #3311)	2	
Threshold Assembly (Die #200)	1	
<b>PACKAGE BP01-96</b>		
33-1/2" x 32" Black Mat with Coarse Ribs and Lock Lip Edge	2	Up to 96" Clear Opening
27-1/2" x 32" Black Mat with Coarse Ribs and Lock Lip Edge	1	
3-sided Trim Kit with 2" Ramp Trim (Die #3311)	2	
Threshold Assembly (Die #200)	1	
33-1/2" x 44" Black Mat with Coarse Ribs and Lock Lip Edge	2	
27-1/2" x 44" Black Mat with Coarse Ribs and Lock Lip Edge	1	

## Bi-Part Slide Doors

Mats Used for Both Activation & Safety – Two Way Traffic

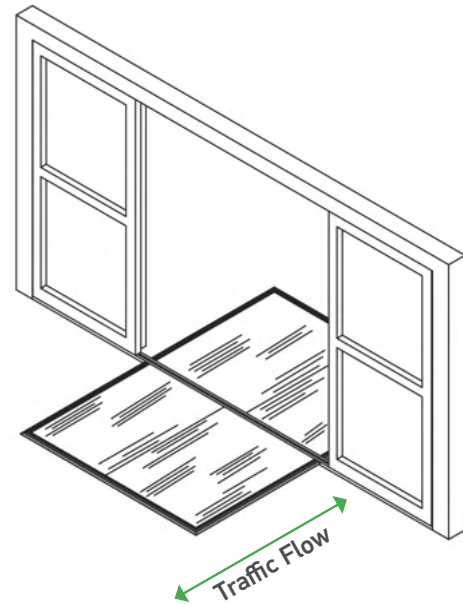
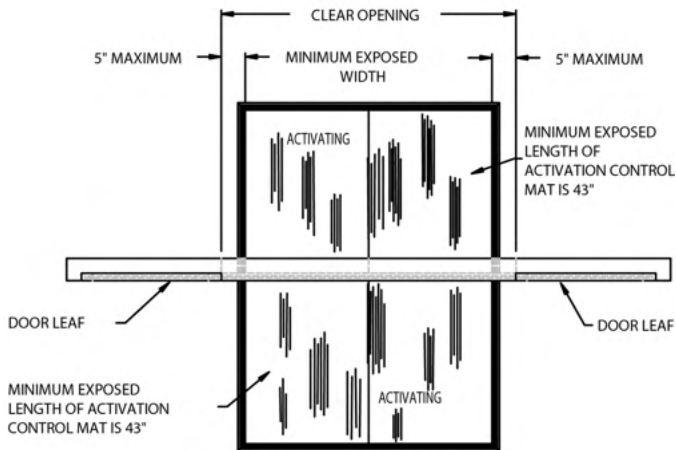

PACKAGE DESCRIPTION	QUANTITY	DOOR OPENING
<b>PACKAGE BP02-48</b>		
40-7/8" x 43-3/16" Black Mat with Coarse Ribs and Lock Lip Edge	2	Up to 48" Clear Opening
3-sided Trim Kit with 2" Ramp Trim (Die #3311)	2	
Threshold Assembly (Die #200)	1	
<b>PACKAGE BP02-60</b>		
27-1/2" x 44" Black Mat with Coarse Ribs and Lock Lip Edge	4	Up to 60" Clear Opening
3-sided Trim Kit with 2" Ramp Trim (Die #3311)	2	
Threshold Assembly (Die #200)	1	
<b>PACKAGE BP02-72</b>		
33-1/2" x 44" Black Mat with Coarse Ribs and Lock Lip Edge	4	Up to 72" Clear Opening
3-sided Trim Kit with 2" Ramp Trim (Die #3311)	2	
Threshold Assembly (Die #200)	1	
<b>PACKAGE BP02-84</b>		
39-1/2" x 44" Black Mat with Coarse Ribs and Lock Lip Edge	4	Up to 84" Clear Opening
3-sided Trim Kit with 2" Ramp Trim (Die #3311)	2	
Threshold Assembly (Die #200)	1	
<b>PACKAGE BP02-96</b>		
28-7/8" x 43-3/16" Black Mat with Coarse Ribs and Lock Lip Edge	6	Up to 96" Clear Opening
3-sided Trim Kit with 2" Ramp Trim (Die #3311)	2	
Threshold Assembly (Die #200)	1	

### Single Fold Doors

#### Mats Used for Both Activation & Safety – One Way Traffic

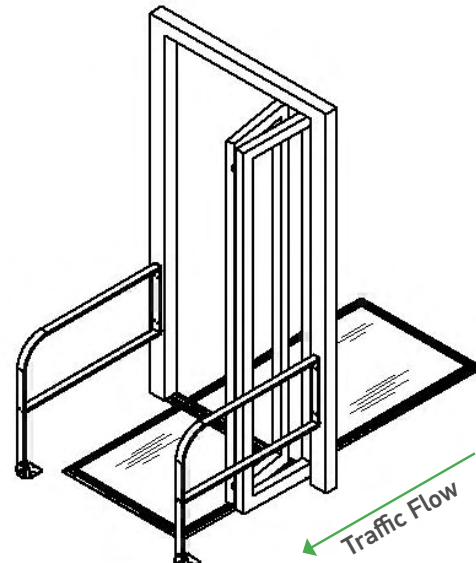
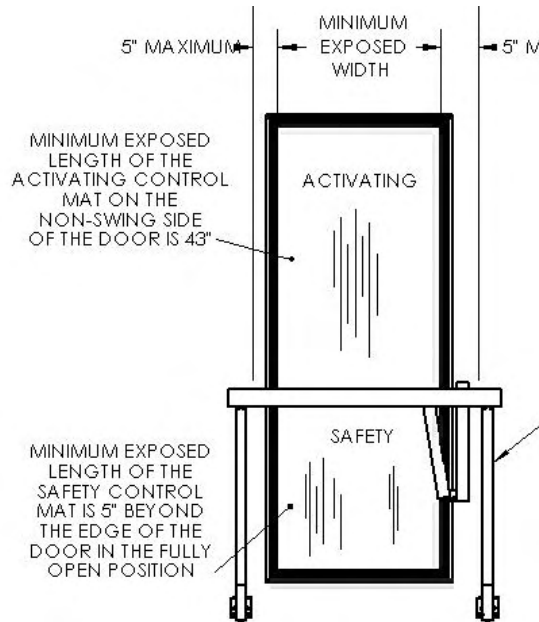

PACKAGE DESCRIPTION	QUANTITY	DOOR OPENING
<b>PACKAGE SF01-36</b>		
27-1/2" x 44" Black Mat with Coarse Ribs and Lock Lip Edge	1	Up to 36"  Largest Leaf is 18"
27-1/2" x 27-1/2" Black Mat with Coarse Ribs and Lock Lip Edge	1	
3-sided Trim Kit with 2" Ramp Trim (Die #3311)	2	
Threshold Assembly (Die #200)	1	
30" x 24" Standard Floor to Wall Double Guide Rails (clear finish)	2	
<b>PACKAGE SF01-42</b>		
34-7/8" x 43-3/16" Black Mat with Coarse Ribs and Lock Lip Edge	1	Up to 42"  Largest Leaf is 22"
34-7/8" x 31-3/16" Black Mat with Coarse Ribs and Lock Lip Edge	1	
3-sided Trim Kit with 2" Ramp Trim (Die #3311)	2	
Threshold Assembly (Die #200)	1	
30" x 30" Standard Floor to Wall Double Guide Rails (clear finish)	2	
<b>PACKAGE SF01-48</b>		
40-7/8" x 43-3/16" Black Mat with Coarse Ribs and Lock Lip Edge	1	Up to 48"  Largest Leaf is 26"
40-7/8" x 31-3/16" Black Mat with Coarse Ribs and Lock Lip Edge	1	
3-sided Trim Kit with 2" Ramp Trim (Die #3311)	2	
Threshold Assembly (Die #200)	1	
30" x 36" Standard Floor to Wall Double Guide Rails (clear finish)	2	

## Single Fold Doors

### Mats Used for Both Activation & Safety – Two Way Traffic

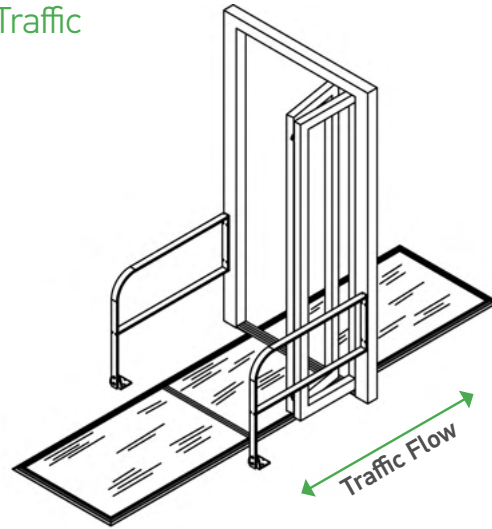
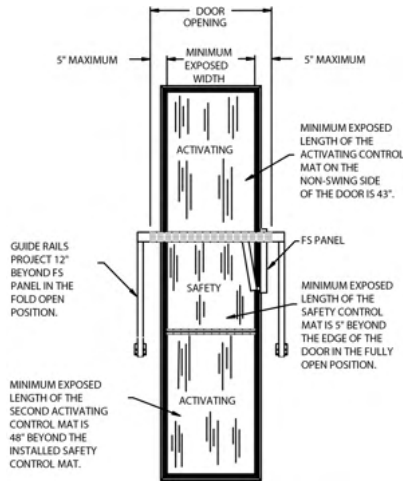

PACKAGE DESCRIPTION	QUANTITY	DOOR OPENING
<b>PACKAGE SF02-36</b>		
27-1/2" x 56" Black Mat with Coarse Ribs and Lock Lip Edge	1	Up to 36"  Largest Leaf is 18"
27-1/2" x 43" Black Mat with Coarse Ribs and Lock Lip Edge	1	
27-1/2" x 27-1/2" Black Mat with Coarse Ribs and Lock Lip Edge	1	
3-sided Trim Kit with 2" Ramp Trim (Die #3311)	1	
3-sided Trim Kit with 2" Ramp Trim and Joining Trim (Die #3311 & 2705)	1	
Threshold Assembly (Die #200)	1	
30" x 30" Standard Floor to Wall Double Guide Rails (clear finish)	2	
<b>PACKAGE SF02-42</b>		
34-7/8" x 55-3/16" Black Mat with Coarse Ribs and Lock Lip Edge	1	Up to 42"  Largest Leaf is 22"
34-7/8" x 43-3/16" Black Mat with Coarse Ribs and Lock Lip Edge	1	
34-7/8" x 31-3/16" Black Mat with Coarse Ribs and Lock Lip Edge	1	
3-sided Trim Kit with 2" Ramp Trim (Die #3311)	1	
3-sided Trim Kit with 2" Ramp Trim and Joining Trim (Die #3311 & 2705)	1	
Threshold Assembly (Die #200)	1	
30" x 30" Standard Floor to Wall Double Guide Rails (clear finish)	2	
<b>PACKAGE SF02-48</b>		
40-7/8" x 55-3/16" Black Mat with Coarse Ribs and Lock Lip Edge	1	Up to 48"  Largest Leaf is 26"
40-7/8" x 43-3/16" Black Mat with Coarse Ribs and Lock Lip Edge	1	
40-7/8" x 31-3/16" Black Mat with Coarse Ribs and Lock Lip Edge	1	
3-sided Trim Kit with 2" Ramp Trim (Die #3311)	1	
3-sided Trim Kit with 2" Ramp Trim and Joining Trim (Die #3311 & 2705)	1	
Threshold Assembly (Die #200)	1	
30" x 36" Standard Floor to Wall Double Guide Rails (clear finish)	2	



### Single Fold Doors

#### Mats Used for Safety Only – One Way Traffic

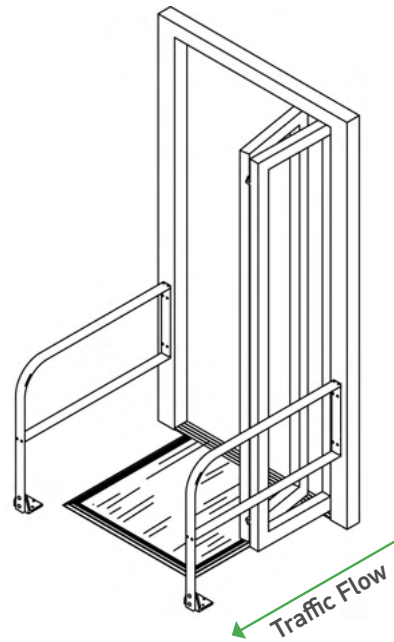
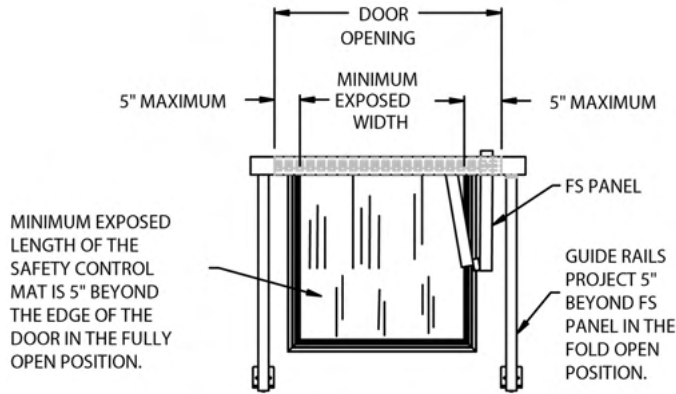

\*Larco recommends presence-sensing mats for both activation and safety for all types of folding doors. For those occasions when a sensor will be used for entry on the approach side of a door, Larco recommends using presence-sensing mats for the safety or swing side of the same door. Additional requirements may apply. Refer to ANSI A156.10 Standard for Power Operated Pedestrian Doors, for additional guidance.

PACKAGE DESCRIPTION	QUANTITY	DOOR OPENING
<b>PACKAGE SF03-36</b>		
27-1/2" x 27-1/2" Black Mat with Coarse Ribs and Lock Lip Edge	1	Up to 36"
3-sided Trim Kit with 2" Ramp Trim (Die #3311)	1	Largest Leaf is 18"
Threshold Kit (Die #1250 & 200)	1	
30" x 24" Standard Floor to Wall Double Guide Rails (clear finish)	2	
<b>PACKAGE SF03-42</b>		
34-7/8" x 31-3/16" Black Mat with Coarse Ribs and Lock Lip Edge	1	Up to 42"
3-sided Trim Kit with 2" Ramp Trim (Die #3311)	1	Largest Leaf is 22"
Threshold Kit (Die #1250 & 200)	1	
30" x 30" Standard Floor to Wall Double Guide Rails (clear finish)	2	
<b>PACKAGE SF03-48</b>		
40-7/8" x 31-3/16" Black Mat with Coarse Ribs and Lock Lip Edge	1	Up to 48"
3-sided Trim Kit with 2" Ramp Trim (Die #3311)	1	Largest Leaf is 26"
Threshold Kit (Die #1250 & 200)	1	
30" x 36" Standard Floor to Wall Double Guide Rails (clear finish)	2	

## Single Fold Doors Mats Used for Fold Side Only – Two Way Traffic

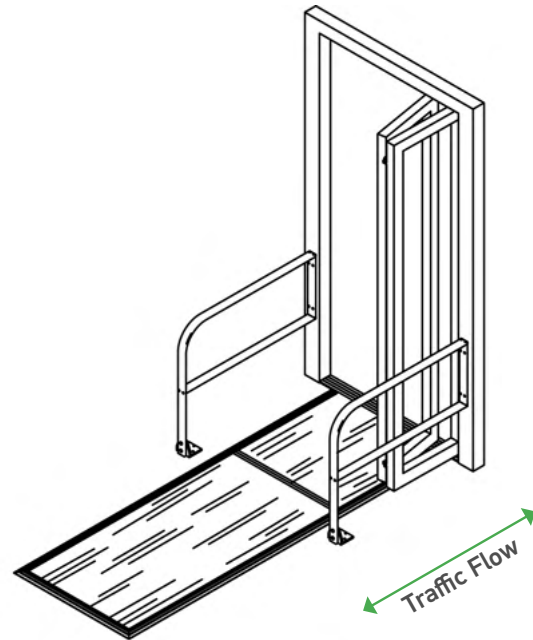
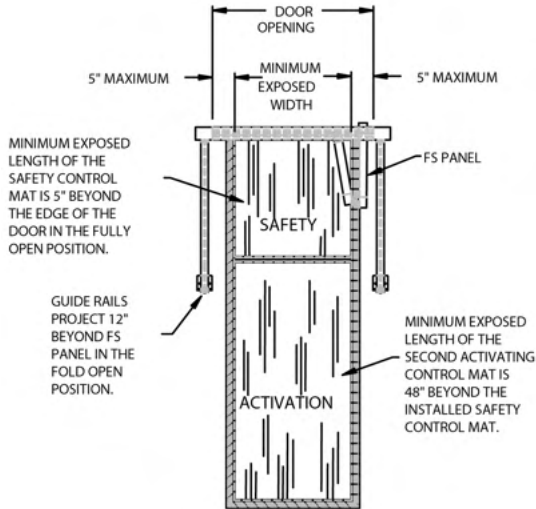

\*Larco recommends presence-sensing mats for both activation and safety for all types of folding doors. For those occasions when a sensor will be used for entry on the approach side of a door, Larco recommends using presence-sensing mats for the safety or swing side of the same door. Additional requirements may apply. Refer to ANSI A156.10 Standard for Power Operated Pedestrian Doors, for additional guidance.

PACKAGE DESCRIPTION	QUANTITY	DOOR OPENING
<b>PACKAGE SF04-36</b>		
27-1/2" x 56" Black Mat with Coarse Ribs and Lock Lip Edge	1	Up to 36"  Largest Leaf is 18"
27-1/2" x 32" Black Mat with Coarse Ribs and Lock Lip Edge	1	
3-sided Trim Kit with 2" Ramp Trim and Joining Trim (Die #3311 & 2705)	1	
Threshold Kit (Die #1250 & 200)	1	
30" x 24" Standard Floor to Wall Double Guide Rails (clear finish)	2	
<b>PACKAGE SF04-42</b>		
34-7/8" x 55-3/16" Black Mat with Coarse Ribs and Lock Lip Edge	1	Up to 42"  Largest Leaf is 22"
34-7/8" x 31-3/16" Black Mat with Coarse Ribs and Lock Lip Edge	1	
3-sided Trim Kit with 2" Ramp Trim and Joining Trim (Die #3311 & 2705)	1	
Threshold Kit (Die #1250 & 200)	1	
30" x 36" Standard Floor to Wall Double Guide Rails (clear finish)	2	
<b>PACKAGE SF04-48</b>		
40-7/8" x 55-3/16" Black Mat with Coarse Ribs and Lock Lip Edge	1	Up to 48"  Largest Leaf is 26"
40-7/8" x 31-3/16" Black Mat with Coarse Ribs and Lock Lip Edge	1	
3-sided Trim Kit with 2" Ramp Trim and Joining Trim (Die #3311 & 2705)	1	
Threshold Kit (Die #1250 & 200)	1	
30" x 36" Standard Floor to Wall Double Guide Rails (clear finish)	2	

### Bi-Fold Doors

#### Mats Used for Both Activation & Safety – One Way Traffic

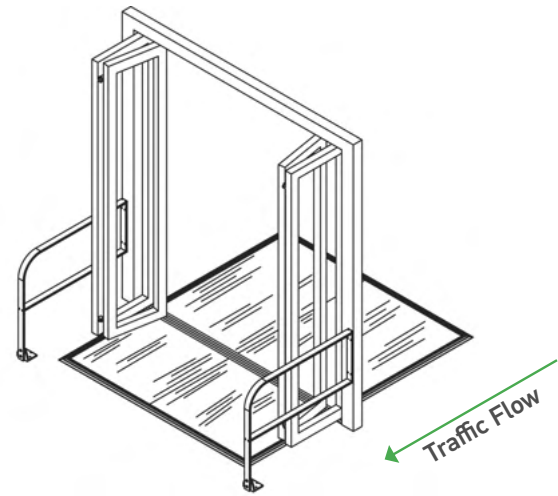
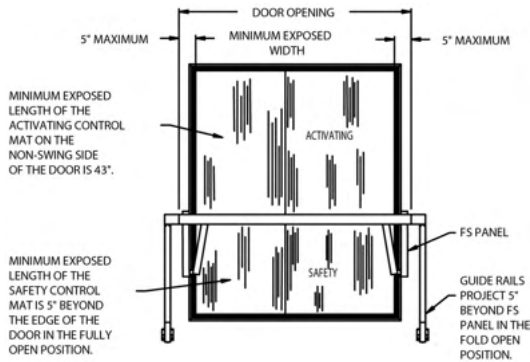

PACKAGE DESCRIPTION	QUANTITY	DOOR OPENING
<b>PACKAGE BF01-60</b>		
27-1/2" x 44" Black Mat with Coarse Ribs and Lock Lip Edge	2	Up to 60"  Largest Leaf is 18"
27-1/2" x 27-1/2" Black Mat with Coarse Ribs and Lock Lip Edge	2	
3-sided Trim Kit with 2" Ramp Trim (Die #3311)	2	
Threshold Assembly (Die #200)	1	
30" x 24" Standard Floor to Wall Double Guide Rails (clear finish)	2	
<b>PACKAGE BF01-72</b>		
33-1/2" x 44" Black Mat with Coarse Ribs and Lock Lip Edge	2	Up to 72"  Largest Leaf is 22"
33-1/2" x 32" Black Mat with Coarse Ribs and Lock Lip Edge	2	
3-sided Trim Kit with 2" Ramp Trim (Die #3311)	2	
Threshold Assembly (Die #200)	1	
30" x 30" Standard Floor to Wall Double Guide Rails (clear finish)	2	
<b>PACKAGE BF01-84</b>		
40-7/8" x 43-3/16" Black Mat with Coarse Ribs and Lock Lip Edge	2	Up to 84"  Largest Leaf is 26"
40-7/8" x 31-3/16" Black Mat with Coarse Ribs and Lock Lip Edge	2	
3-sided Trim Kit with 2" Ramp Trim (Die #3311)	2	
Threshold Assembly (Die #200)	1	
30" x 36" Standard Floor to Wall Double Guide Rails (clear finish)	2	
<b>PACKAGE BF01-96</b>		
33-1/2" x 44" Black Mat with Coarse Ribs and Lock Lip Edge	1	Up to 98"  Largest Leaf is 28"
33-1/2" x 32" Black Mat with Coarse Ribs and Lock Lip Edge	1	
27-1/2" x 44" Black Mat with Coarse Ribs and Lock Lip Edge	2	
27-1/2" x 32" Black Mat with Coarse Ribs and Lock Lip Edge	2	
3-sided Trim Kit with 2" Ramp Trim (Die #3311)	2	
Threshold Assembly (Die #200)	1	
30" x 36" Standard Floor to Wall Double Guide Rails (clear finish)	2	

## Bi-Fold Doors

Mats Used for Both Activation & Safety – Two Way Traffic

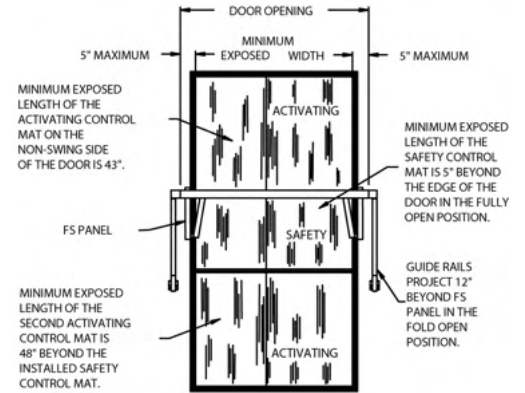
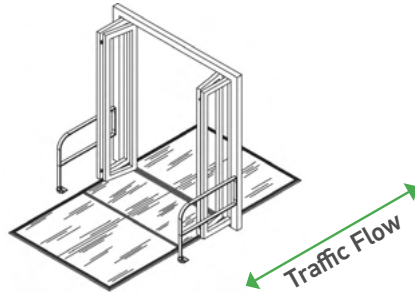

PACKAGE DESCRIPTION	QUANTITY	DOOR OPENING
<b>PACKAGE BF02-60</b>		
27-1/2" x 56" Black Mat with Coarse Ribs and Lock Lip Edge	2	Up to 60"  Largest Leaf is 18"
27-1/2" x 32-1/2" Black Mat with Coarse Ribs and Lock Lip Edge	2	
27-1/2" x 44" Black Mat with Coarse Ribs and Lock Lip Edge	2	
3-sided Trim Kit with 2" Ramp Trim (Die #3311)	1	
3-sided Trim Kit with 2" Ramp Trim and Joining Trim (Die #3311 & 2705)	1	
Threshold Assembly (Die #200)	1	
30" x 30" Standard Floor to Wall Double Guide Rails (clear finish)	2	
<b>PACKAGE BF02-72</b>		
33-1/2" x 56" Black Mat with Coarse Ribs and Lock Lip Edge	2	Up to 72"  Largest Leaf is 22"
33-1/2" x 44" Black Mat with Coarse Ribs and Lock Lip Edge	2	
33-1/2" x 32" Black Mat with Coarse Ribs and Lock Lip Edge	2	
3-sided Trim Kit with 2" Ramp Trim (Die #3311)	1	
3-sided Trim Kit with 2" Ramp Trim and Joining Trim (Die #3311 & 2705)	1	
Threshold Assembly (Die #200)	1	
30" x 30" Standard Floor to Wall Double Guide Rails (clear finish)	2	
<b>PACKAGE BF02-84</b>		
40-7/8" x 55-3/16" Black Mat with Coarse Ribs and Lock Lip Edge	2	Up to 84"  Largest Leaf is 26"
40-7/8" x 43-3/16" Black Mat with Coarse Ribs and Lock Lip Edge	2	
40-7/8" x 31-3/16" Black Mat with Coarse Ribs and Lock Lip Edge	2	
3-sided Trim Kit with 2" Ramp Trim (Die #3311)	1	
3-sided Trim Kit with 2" Ramp Trim and Joining Trim (Die #3311 & 2705)	1	
Threshold Assembly (Die #200)	1	
30" x 36" Standard Floor to Wall Double Guide Rails (clear finish)	2	
<b>PACKAGE BF02-96</b>		
28-7/8" x 32-1/2" Black Mat with Coarse Ribs and Lock Lip Edge	3	Up to 96"  Largest Leaf is 28"
28-7/8" x 55-3/16" Black Mat with Coarse Ribs and Lock Lip Edge	3	
28-7/8" x 43-3/16" Black Mat with Coarse Ribs and Lock Lip Edge	3	
3-sided Trim Kit with 2" Ramp Trim (Die #3311)	1	
3-sided Trim Kit with 2" Ramp Trim and Joining Trim (Die #3311 & 2705)	1	
Threshold Assembly (Die #200)	1	
30" x 36" Standard Floor to Wall Double Guide Rails (clear finish)	2	

### Bi-Fold Doors

#### Mats Used for Safety Only – One Way Traffic

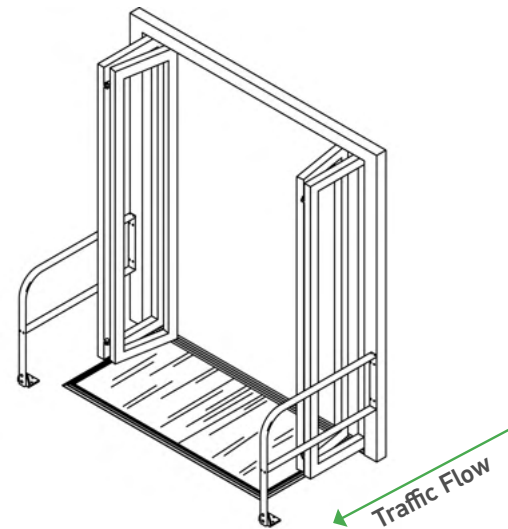
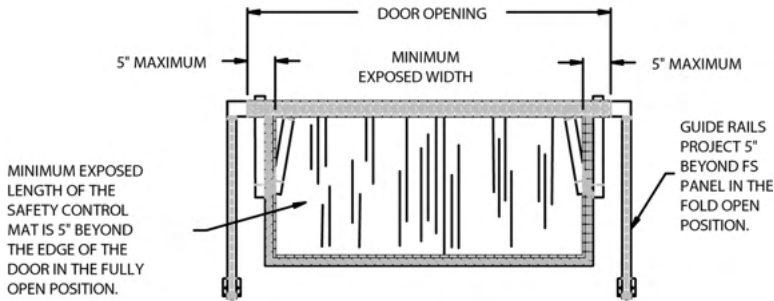

\*Larco recommends presence-sensing mats for both activation and safety for all types of folding doors. For those occasions when a sensor will be used for entry on the approach side of a door, Larco recommends using presence-sensing mats for the safety or swing side of the same door. Additional requirements may apply. Refer to ANSI A156.10 Standard for Power Operated Pedestrian Doors, for additional guidance.

PACKAGE DESCRIPTION	QUANTITY	DOOR OPENING
<b>PACKAGE BF03-60</b>		
27-1/2" x 27-1/2" Black Mat with Coarse Ribs and Lock Lip Edge	2	Up to 60"  Largest Leaf is 18"
3-sided Trim Kit with 2" Ramp Trim (Die #3311)	1	
Threshold Kit (Die #1250 & 200)	1	
30" x 24" Standard Floor to Wall Double Guide Rails (clear finish)	2	
<b>PACKAGE BF03-72</b>		
33-1/2" x 32" Black Mat with Coarse Ribs and Lock Lip Edge	2	Up to 72"  Largest Leaf is 22"
3-sided Trim Kit with 2" Ramp Trim (Die #3311)	1	
Threshold Kit (Die #1250 & 200)	1	
30" x 30" Standard Floor to Wall Double Guide Rails (clear finish)	2	
<b>PACKAGE BF03-84</b>		
40-7/8" x 31-3/16" Black Mat with Coarse Ribs and Lock Lip Edge	2	Up to 84"  Largest Leaf is 26"
3-sided Trim Kit with 2" Ramp Trim (Die #3311)	1	
Threshold Kit (Die #1250 & 200)	1	
30" x 36" Standard Floor to Wall Double Guide Rails (clear finish)	2	
<b>PACKAGE BF03-96</b>		
33-1/2" x 44" Black Mat with Coarse Ribs and Lock Lip Edge	1	Up to 96"  Largest Leaf is 28"
27-1/2" x 44" Black Mat with Coarse Ribs and Lock Lip Edge	2	
3-sided Trim Kit with 2" Ramp Trim (Die #3311)	1	
Threshold Kit (Die #1250 & 200)	1	
30" x 36" Standard Floor to Wall Double Guide Rails (clear finish)	2	

## Bi-Fold Doors

### Mats Used on Fold Side Only – Two Way Traffic

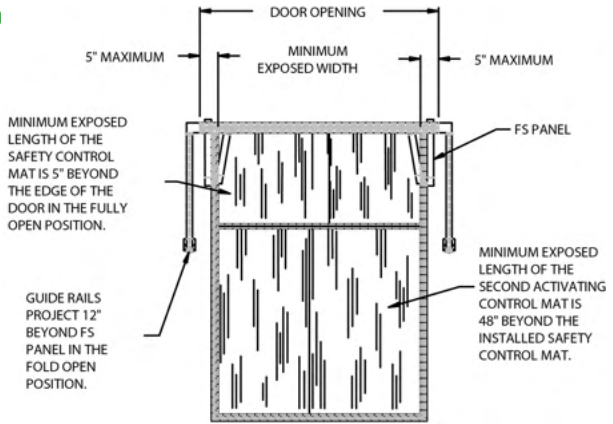
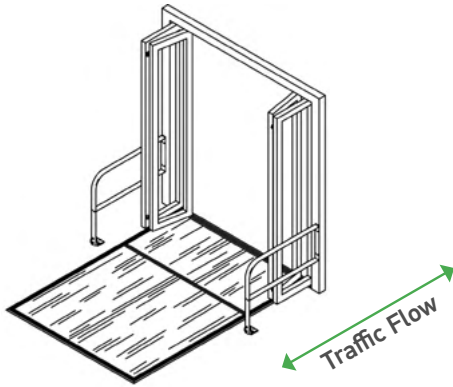

\*Larco recommends presence-sensing mats for both activation and safety for all types of folding doors. For those occasions when a sensor will be used for entry on the approach side of a door, Larco recommends using presence-sensing mats for the safety or swing side of the same door. Additional requirements may apply. Refer to ANSI A156.10 Standard for Power Operated Pedestrian Doors, for additional guidance.

PACKAGE DESCRIPTION	QUANTITY	DOOR OPENING
<b>PACKAGE BF04-60</b>		
27-1/2" x 56" Black Mat with Coarse Ribs and Lock Lip Edge	2	Up to 60"  Largest Leaf is 18"
27-1/2" x 27-1/2" Black Mat with Coarse Ribs and Lock Lip Edge	2	
3-sided Trim Kit with 2" Ramp Trim and Joining Trim (Die #3311 & 2705)	1	
Threshold Kit (Die #1250 & 200)	1	
30" x 30" Standard Floor to Wall Double Guide Rails (clear finish)	2	
<b>PACKAGE BF04-72</b>		
33-1/2" x 32" Black Mat with Coarse Ribs and Lock Lip Edge	2	Up to 72"  Largest Leaf is 22"
33-1/2" x 56" Black Mat with Coarse Ribs and Lock Lip Edge	2	
3-sided Trim Kit with 2" Ramp Trim and Joining Trim (Die #3311 & 2705)	1	
Threshold Kit (Die #1250 & 200)	1	
30" x 30" Standard Floor to Wall Double Guide Rails (clear finish)	2	
<b>PACKAGE BF04-84</b>		
40 7/8" x 55 3/16" Black Mat with Coarse Ribs and Lock Lip Edge	2	Up to 84"  Largest Leaf is 26"
40 7/8" x 31 3/16" Black Mat with Coarse Ribs and Lock Lip Edge	2	
3-sided Trim Kit with 2" Ramp Trim and Joining Trim (Die #3311 & 2705)	1	
Threshold Kit (Die #1250 & 200)	1	
30" x 36" Standard Floor to Wall Double Guide Rails (clear finish)	2	
<b>PACKAGE BF04-96</b>		
27-1/2" x 44" Black Mat with Coarse Ribs and Lock Lip Edge	4	Up to 96"  Largest Leaf is 28"
33-1/2" x 44" Black Mat with Coarse Ribs and Lock Lip Edge	2	
3-sided Trim Kit with 2" Ramp Trim and Joining Trim (Die #3311 & 2705)	1	
Threshold Kit (Die #1250 & 200)	1	
30" x 36" Standard Floor to Wall Double Guide Rails (clear finish)	2	

# Mat Options

## Variety of Specifications to Meet Most Door Applications

### Color

Please specify color when ordering. The standard Larco colors are black and brown. Other colors are available on request; contact us for pricing.

### Monograms

Standard monograms, such as arrows, are available; as an option and additional to the base price of the mat. Two-color monograms, such as the International "Do Not Enter" symbol are also available. Pricing for custom monograms, logos and greetings is available upon request.

### Special Sizes

All Larco mats can be custom-made to fit non-standard applications. Please contact us for pricing or use these general rules:

1. Special length or width.
2. Special length and width.
3. Special angles, notches and/or radii.
4. Special pie-shaped mats: Contact us for pricing.

### Inactive Mats

All Larco mats are available in non-active form for use as fillers in non-standard applications. They are constructed using one sheet of steel to add rigidity and control shrinkage. For inactive mats with one sheet of steel, specify "inactive."

Solid vinyl inactive mats with no steel are available and can be cut to fit on the job site with a razor knife.

CAUTION: Without steel, the mat will shrink to some degree, depending on the size of the mat. For inactive mats without steel, specify "inactive-no steel."

### Lead Wire

The standard length of lead wire on all Larco mats is approximately 12 feet. The normal exit location for the lead wire is in the center of the mat width. Custom lead lengths and cord exits are available; contact us for pricing.



## Standard Mat Sizes Lock Lip-Edge Mats

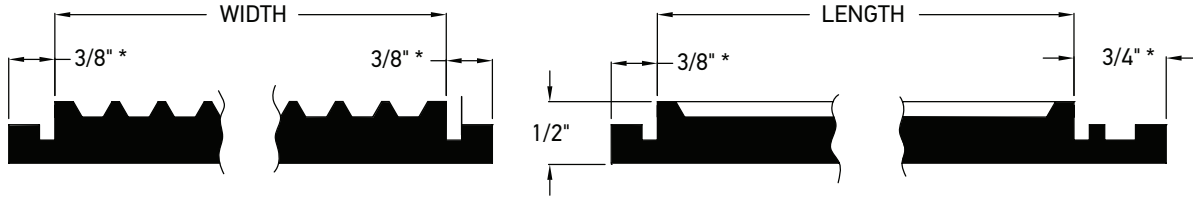

### 1/2" Thick, Lock Lip-Edge, Coarse Ribs

MODEL NUMBER	PART NUMBER	MAT LENGTH	ESTIMATED SHIPPING WEIGHT
<b>24" WIDTH</b>			
2448	338282	48"	32
2460	338283	60"	47
<b>27-1/2" WIDTH</b>			
3030*	210007	27-1/2"	24
1204-5*	210005	32-1/2"	28
1204-2*	210004	43"	37
1204-1*	210006	57"	53
8153*	210047	32"	27
8152*	210038	44"	39
8151*	210039	56"	49
<b>28-7/8" WIDTH</b>			
3036*	210012	31-3/16"	28
3048*	210010	43-3/16"	40
1207-5*	210011	32-1/2"	30
1207-2*	210009	45-7/8"	44
1207-1*	210008	55-3/16"	54
<b>33-1/2" WIDTH</b>			
8156*	210048	32"	33
8155*	210049	44"	45
8154	210050	56"	57

MODEL NUMBER	PART NUMBER	MAT LENGTH	ESTIMATED SHIPPING WEIGHT
<b>34-7/8" WIDTH</b>			
1237-5*	210015	31-3/16"	36
1237-2*	210014	43-3/16"	51
1237-1	210013	55-3/16"	60
<b>36" WIDTH</b>			
3648*	214754	48"	55
3660	338176	60"	71
3672	215520	72"	87
<b>39-1/2" WIDTH</b>			
8158	210051	44"	52
8157	210052	56"	66
<b>40-7/8" WIDTH</b>			
1243-5*	210437	31-3/16"	41
1243-2	210017	43-3/16"	57
1243-1	210016	55-3/16"	75
<b>48" WIDTH</b>			
4848	232291	48"	72
4860	337075	60"	94
4872	232293	72"	115

\* Denotes mats that may be shipped via UPS.

Standard Mat Sizes  
Tapered-Edge Mats

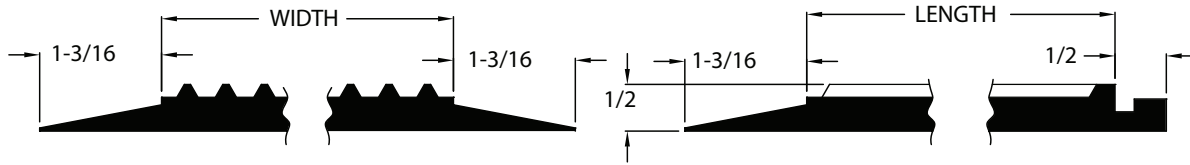

1/2" Thick, Tapered-Edge, Coarse Ribs

MODEL NUMBER	PART NUMBER	MAT LENGTH	ESTIMATED SHIPPING WEIGHT
<b>27-1/2" WIDTH</b>			
1606*	211714	33-3/8"	34
1605*	210032	44-3/4"	45
<b>34-3/4" WIDTH</b>			
1637*	212947	33-3/8"	41
1636*	210754	44-3/4"	55

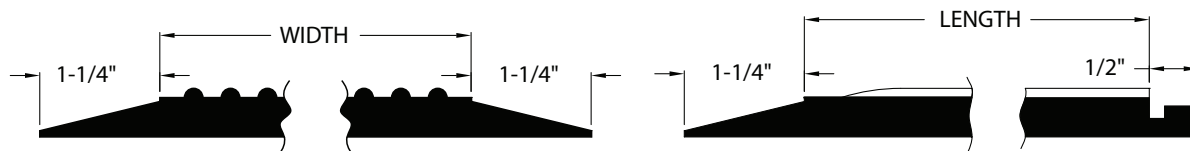

1/2" Thick, Tapered-Edge, Rounded Ribs (replaces Dor-O-Matic manufactured mats)

DOM CARPET NUMBER	LARCO PART NUMBER	MAT LENGTH	ESTIMATED SHIPPING WEIGHT
<b>27-7/16" WIDTH</b>			
1605 M6*	229787	44-3/4"	40
1659 M6*	231933	56-9/16"	65
<b>34-3/4" WIDTH</b>			
1636 M6*	230896	44-3/4"	50
1669 M6	231934	56-9/16"	65

\* Denotes mats that may be shipped via UPS.

## Standard Mat Sizes Square-Edge Mats

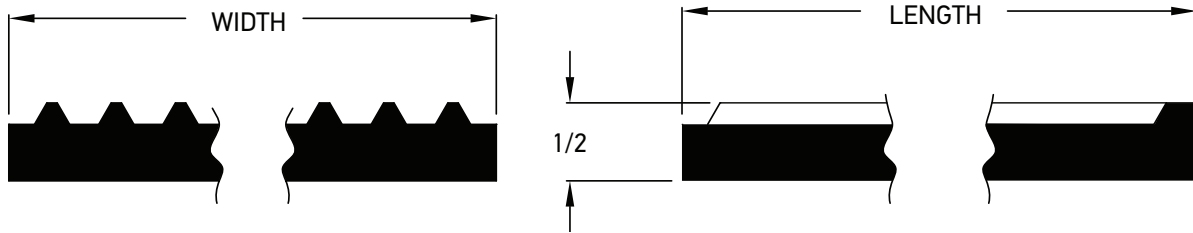

1/2" Thick, Square-Edge (taper removed), Coarse Ribs

MODEL NUMBER	PART NUMBER	MAT LENGTH	ESTIMATED SHIPPING WEIGHT
<b>27-1/2" WIDTH</b>			
1606-1*	232368	33-3/8"	33
1605-1*	232367	44-3/4"	44
1659-1*	211511	56-1/4"	48

MODEL NUMBER	PART NUMBER	MAT LENGTH	ESTIMATED SHIPPING WEIGHT
<b>34-3/4" WIDTH</b>			
1637-1*	232370	33-3/8"	40
1636-1*	232369	44-3/4"	54
1669-1	210766	56-1/4"	61
<b>40-3/16" WIDTH</b>			
1639-1	210058	56-3/16"	69

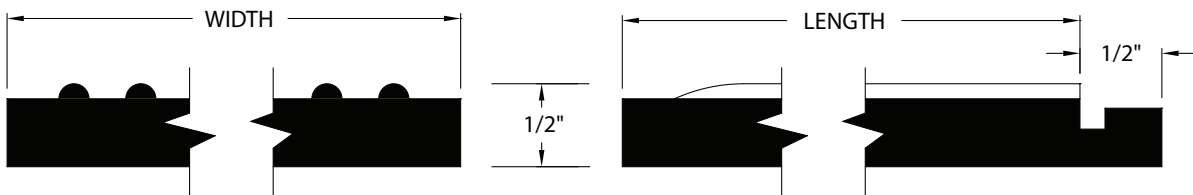

1/2" Thick, Square-Edge (bevel removed), Rounded Ribs (replaces Dor-O-Matic manufactured mats)

DOM CARPET NUMBER	LARCO PART NUMBER	MAT LENGTH	ESTIMATED SHIPPING WEIGHT
<b>27-7/16" WIDTH</b>			
1605-1M6*	231262	44-3/4"	38
1659-1M6*	230919	56-9/16"	63
<b>34 -3/4" WIDTH</b>			
1636-1M6*	231932	44-3/4"	48
1669-1M6	231694	56-9/16"	63
<b>40-3/16" WIDTH</b>			
1639-1M6	210058	56-3/16"	69

\* Denotes mats that may be shipped via UPS.

Standard Mat Sizes  
Bevel-Edge Mats

3/8" Thick, Bevel-Edge, Fine Rib Mats

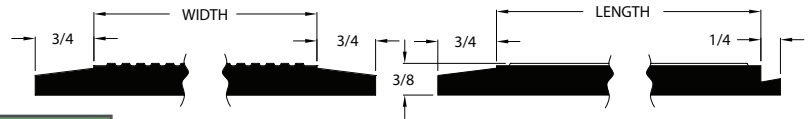

MODEL NUMBER	PART NUMBER	MAT LENGTH	EST. SHIPPING WEIGHT
<b>27" WIDTH</b>			
1228-35*	210053	36"	35
1228-3*	210045	45"	41
1228-1*	211407	59"	51
<b>35" WIDTH</b>			
1236-35*	210054	36"	46
1236-3*	210046	45"	53
1236-1	210055	59"	63

Square-Edge Mats

3/8" Thick, Straight-Edge, Coarse Ribs

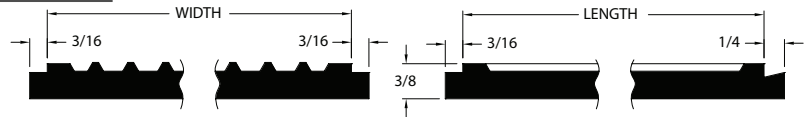

MODEL NUMBER	PART NUMBER	MAT LENGTH	EST. SHIPPING WEIGHT
<b>24-1/8" WIDTH</b>			
1224-5*	210036	36-9/16"	31
1224-2*	210028	45-9/16"	35
<b>28-1/8" WIDTH</b>			
1228-5*	210024	36-9/16"	31
1228-2*	210502	45-9/16"	38
<b>36-1/8" WIDTH</b>			
1236-5*	210042	36-9/16"	40
1236-2	210029	45-9/16"	49

3/8" Thick, Straight-Edge, Ultra-Fine Rib Mats  
(replaces Stanley manufactured mats)

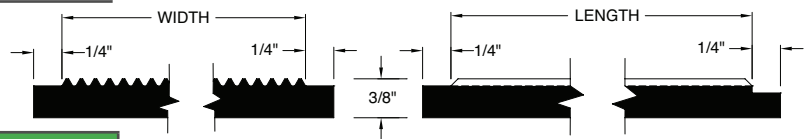

STANLEY MODEL #	PART NUMBER	MAT LENGTH	EST. SHIPPING WEIGHT
<b>28" WIDTH</b>			
SC2835*	232443	36-3/4"	35
SC2845*	228467	45-1/2"	41
SC2860*	232445	59-1/2"	45
<b>36" WIDTH</b>			
SC3635*	232446	36-3/4"	46
SC3645*	228469	45-1/2"	53
SC3660	232448	59 1/2 "	59

\* Denotes mats that may be shipped via UPS.

## Standard Mat Sizes Specialty Mats

### Watchdog Mat (1200-14) 14" x 24-1/2"

PART NUMBER	SHIPPING WEIGHT
210018*	10

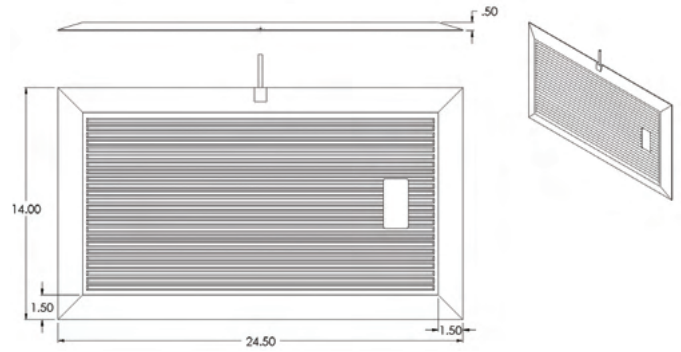
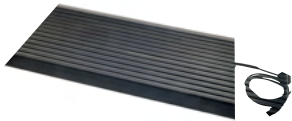

### Footswitch Mat 5" x 8"

PART NUMBER	SHIPPING WEIGHT
212419*	2

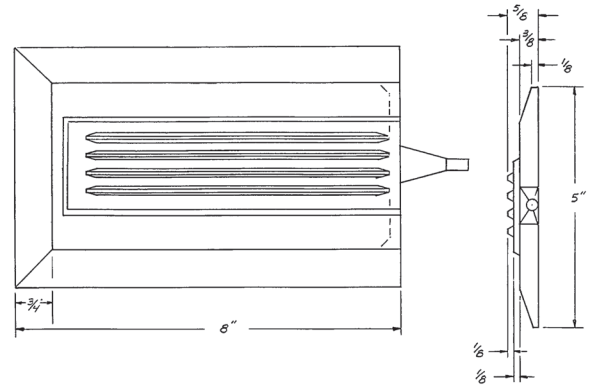
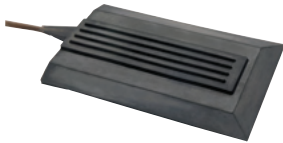

### Rollover Mat (1200-8) 8" x 24"

PART NUMBER	SHIPPING WEIGHT
210021*	7

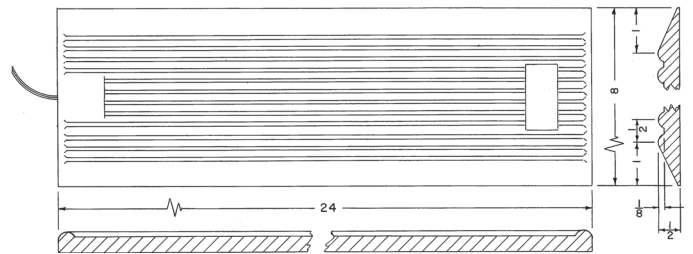
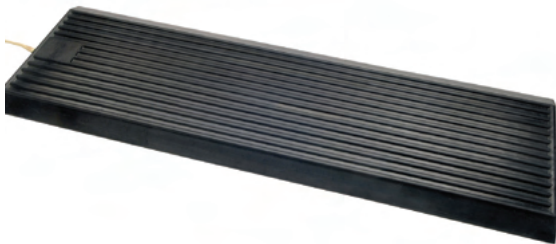

# Aluminum Mat Trim

## Durable Mounting Solutions for Tough Environments

Designed to withstand even the harshest environments, including heavy traffic, Larco mat trims offer a durable and reliable way to install any automatic door mat.

All Larco aluminum mat trim is made from hard aluminum for durability. Samples are available on request.

### Finish Options

Special finishes, including a bronze or clear anodized finish, are available for an additional charge. Other anodized trims also are available, contact us for additional information.

### Stock Lengths

Larco extrusions are available in the stock lengths listed in the table on the next page. Trim can be cut for UPS shipping. The maximum stock length trim UPS accepts is 104".

**Important: Standard shipping rates apply to Extrusions cut to 93" or less. Lengths over 93" will be charged additional shipping fees by UPS. Please request specific cutting lengths when placing order.**

### Trim Kits















In addition to the stock lengths listed on the next page, Larco extrusions can be purchased fully machined and installation-ready. They are individually packaged and include stainless steel mounting hardware.

- Durable construction designed to take punishment from wheel chairs, dollies, moving equipment and grocery carts
- Attractive finish with several color options
- Available in stock lengths or in customized packages designed to accommodate specific mat sizes and installations



WARNING: Cancer and Reproductive Harm - [www.P65Warnings.ca.gov](http://www.P65Warnings.ca.gov)

## Aluminum Extrusions Stock Length Dimensions & Details

DETAIL	DESCRIPTION	PART NUMBER	STOCK LENGTH
	4" Ramp Trim Die #1100	211234	143"
	2-3/4" Ramp Trim Die #1800	211841	144"
	2-1/2" Ramp Trim Die #1714	210976	132"
	2-1/2" Ramp Trim Die #1814	211926	132"
	2" Ramp Trim Die #3311	219033	130"
	2" Ramp Trim Die #1049	210975	139"
	3/4" Recessed Trim Die #1057	210978	125"
	2-1/2" Beveled Lead-up Die #1250	211488	120"
	3" Threshold/Joining Strip Die #1048	210972	145"
	2" Threshold/Joining Strip Die #1051	211447	120"
	2" Threshold/Joining Strip Die #200	212069	120"
	1-3/8" Joining Strip Die #2705	214327	120"
	2-3/4" Dovetail Threshold Die #1530 & #1535	211501 211502	115" 115"
	1" Dovetail Joining Strip Die #1510 & #1515	211521 211522	115" 115"

\*UPS will accept up to 104" length stock extrusions and trim kits. **Important:** To avoid length fees by UPS, cut at length no more than 93".



# Automatic Door Products Product List



The power of control. Automated.

## Trim Kits 4" Ramp Trim – Die #1100

		SINGLE MATS	SIDE-BY-SIDE MATS
MAT MODEL NUMBER	MAT LENGTH	TRIM KIT PART NUMBER	TRIM KIT PART NUMBER
<b>24-1/8" WIDTH</b>			
1224-5	36-9/16"	211263	215467
<b>27" WIDTH</b>			
1228-35	36"	214091	215461
<b>27-1/2" WIDTH</b>			
3030	27-1/2"	211236	215422
8153	32"	211240	215445
1204-5	32-1/2"	211237	215443
1606**	33-3/8"	214090	215459
<b>28-1/8" WIDTH</b>			
1228-5	36-9/16"	211265	215464
<b>28-7/8" WIDTH</b>			
3036	31-3/16"	211244	215447
1207-5	32-1/2"	211245	215448
<b>33-1/2" WIDTH</b>			
8156	32"	211249	215450
<b>34-7/8" WIDTH</b>			
1237-5	31-3/16"	211253	215452
<b>35" WIDTH</b>			
1236-35	36"	214093	215469
<b>36-1/8" WIDTH</b>			
1236-5	36-9/16"	211267	215471
<b>24-1/8" WIDTH</b>			
1224-2	45-9/16"	211264	212429
<b>27" WIDTH</b>			
1228-3	45"	211331	215443
<b>27-1/2" WIDTH</b>			
1204-2	43"	211238	211766
8152	44"	211241	215470
1605**	44-3/4"	211286	212121
<b>28-1/8" WIDTH</b>			
1228-2	45-9/16"	211266	212166
<b>28-7/8" WIDTH</b>			
3048	43-3/16"	211246	215449
1207-2	45-7/8"	211247	215453
<b>33-1/2" WIDTH</b>			
8155	44"	211250	212337



This trim provides a gentle slope to the mat surface, making it excellent for use in applications with wheelchair traffic.

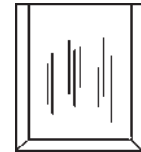

Single-Mat Installations

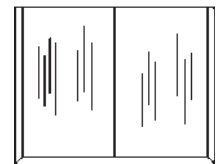

Side-by-Side Mat Installations

\*\* A portion of the tapered edge must be removed to utilize this trim.

## Trim Kits 4" Ramp Trim – Die #1100

		SINGLE MATS	SIDE-BY-SIDE MATS
MAT MODEL NUMBER	MAT LENGTH	TRIM KIT PART NUMBER	TRIM KIT PART NUMBER
<b>34-3/4" WIDTH</b>			
1636**	44-1/4"	211287	215472
<b>34-7/8" WIDTH</b>			
1237-2	43-3/16"	211254	215465
<b>35" WIDTH</b>			
1236-3	45"	214094	215455
<b>36-1/8" WIDTH</b>			
1236-2	45-9/16"	211268	212121
<b>40-7/8" WIDTH</b>			
1243-5	31-3/16"	211259	215468
1243-2	43-3/16"	211260	215463
<b>27" WIDTH</b>			
1228-1	59"	214092	215446
<b>27-1/2" WIDTH</b>			
8151	56"	211242	215473
1659-1	56-1/4"	214096	215444
1204-1	57"	211239	212851
<b>28-7/8" WIDTH</b>			
1207-1	55-3/16"	211248	215451
<b>33-1/2" WIDTH</b>			
8154	56"	211251	215460
<b>34-3/4" WIDTH</b>			
1669-1	56-1/4"	214097	215474
<b>34-7/8" WIDTH</b>			
1237-1	55-3/16"	211255	212179
<b>35" WIDTH</b>			
1236-1	59"	214095	215466
<b>36" WIDTH</b>			
3648	48"	233778	233781
<b>39-1/2" WIDTH</b>			
8158	44"	211256	215454
8157	56"	211257	212911
<b>40-3/16" WIDTH</b>			
1639-1	56-3/16"	211280	215457
<b>40-7/8" WIDTH</b>			
1243-1	55-3/16"	211261	215456
<b>48" WIDTH</b>			
4848	48"	233779	233782



This trim provides a gentle slope to the mat surface, making it excellent for use in applications with wheelchair traffic.

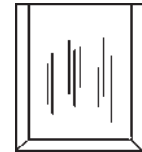

Single-Mat Installations

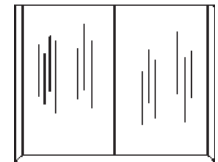

Side-by-Side Mat Installations

\*\* A portion of the tapered edge must be removed to utilize this trim.

# Automatic Door Products Product List



The power of control. Automated.

## Trim Kits 2 3/4" Ramp Trim – Die #1800

		SINGLE MATS	SIDE-BY-SIDE MATS
MAT MODEL NUMBER	MAT LENGTH	TRIM KIT PART NUMBER	TRIM KIT PART NUMBER
<b>24-1/8" WIDTH</b>			
1224-5	36-9/16"	211883	215434
<b>27" WIDTH</b>			
1228-35	36"	211877	215428
<b>27-1/2" WIDTH</b>			
3030	27-1/2"	214098	215397
8153	32"	214101	215401
1204-5	32-1/2"	214099	215398
1606**	33-3/8"	214121	215426
<b>28-1/8" WIDTH</b>			
1228-5	36-9/16"	211885	215436
<b>28-7/8" WIDTH</b>			
3036	31-3/16"	214104	215404
1207-5	32-1/2"	214105	215405
<b>33-1/2" WIDTH</b>			
8156	32"	214109	215409
<b>34-7/8" WIDTH</b>			
1237-5	31-3/16"	214112	215412
<b>35" WIDTH</b>			
1236-35	36"	211880	215431
<b>36-1/8" WIDTH</b>			
1236-5	36-9/16"	211887	215438
<b>24-1/8" WIDTH</b>			
1224-2	45-9/16"	211884	215435
<b>27" WIDTH</b>			
1228-3	45"	211878	215429
<b>27-1/2" WIDTH</b>			
1204-2	43"	214100	215399
8152	44"	214102	215402
1605**	44-3/4"	214120	215421
<b>28-1/8" WIDTH</b>			
1228-2	45-9/16"	211886	215437
<b>28-7/8" WIDTH</b>			
3048	43-3/16"	214106	215406
1207-2	45-7/8"	214107	215407
<b>33-1/2" WIDTH</b>			
8155	44"	214110	215410



Designed to take heavy loads, this heavy-duty trim is best for environments with high pedestrian or shopping cart traffic.

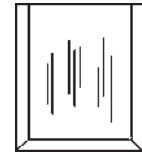

Single-Mat Installations

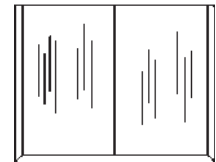

Side-by-Side Mat Installations

\*\* A portion of the tapered edge must be removed to utilize this trim.

## Trim Kits 2-3/4" Ramp Trim – Die #1800

		SINGLE MATS	SIDE-BY-SIDE MATS
MAT MODEL NUMBER	MAT LENGTH	TRIM KIT PART NUMBER	TRIM KIT PART NUMBER
<b>34-3/4" WIDTH</b>			
1636**	44-3/4"	214122	215427
<b>34-7/8" WIDTH</b>			
1237-2	43-3/16"	214113	215413
<b>35" WIDTH</b>			
1236-3	45"	211881	215432
<b>36-1/8" WIDTH</b>			
1236-2	45-9/16"	211888	215439
<b>39-1/2" WIDTH</b>			
8158	44"	214115	215415
<b>40-7/8" WIDTH</b>			
1243-5	31-3/16"	214117	215417
1243-2	43-3/16"	214118	215418
<b>27" WIDTH</b>			
1228-1	59"	211879	215430
<b>27-1/2" WIDTH</b>			
8151	56"	214103	215403
1659-1	56-1/4"	214129	215440
1204-1	57"	212239	215400
<b>28-7/8" WIDTH</b>			
1207-1	55-3/16"	214108	215408
<b>33-1/2" WIDTH</b>			
8154	56"	214111	215411
<b>34-3/4" WIDTH</b>			
1669-1	56-1/4"	214130	215441
<b>34-7/8" WIDTH</b>			
1237-1	55-3/16"	214114	215414
<b>35" WIDTH</b>			
1236-1	59"	211882	215433
<b>36" WIDTH</b>			
3648	48"	233783	233786
<b>39-1/2" WIDTH</b>			
8157	56"	214116	215416
<b>40-3/16" WIDTH</b>			
1639-1	56-3/16"	214119	215420
<b>40-7/8" WIDTH</b>			
1243-1	55-3/16"	211995	220143



Designed to take heavy loads, this heavy-duty trim is best for environments with high pedestrian or shopping cart traffic.

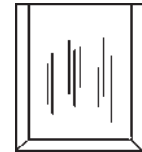

Single-Mat Installations

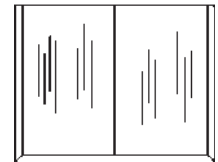

Side-by-Side Mat Installations

# Automatic Door Products Product List



The power of control. Automated.

## Trim Kits 2-1/2" Ramp Trim – Die #1714

		SINGLE MATS	SIDE-BY-SIDE MATS
MAT MODEL NUMBER	MAT LENGTH	TRIM KIT PART NUMBER	TRIM KIT PART NUMBER
<b>27-1/2" WIDTH</b>			
3030	27-1/2"	210943	215311
8153	32"	211210	215312
1204-5	32-1/2"	210348	213094
1606**	33-3/8"	214131	215324
<b>28-7/8" WIDTH</b>			
3036	31-3/16"	210955	212004
1207-5	32-1/2"	210351	215314
<b>33-1/2" WIDTH</b>			
8156	32"	211214	215315
<b>34-7/8" WIDTH</b>			
1237-5	31-3/16"	210354	215318
<b>27-1/2" WIDTH</b>			
1204-2	43"	210347	211133
8152	44"	210949	211131
1605**	44-3/4"	211283	215323
<b>28-7/8" WIDTH</b>			
3048	43-3/16"	210958	210759
1207-2	45-7/8"	210350	211749
<b>33-1/2" WIDTH</b>			
8155	44"	211217	215316
<b>34-3/4" WIDTH</b>			
1636**	44-3/4"	211284	215325
<b>34-7/8" WIDTH</b>			
1237-2	43-3/16"	210353	212103
<b>39-1/2" WIDTH</b>			
8158	44"	211223	214018
<b>40-7/8" WIDTH</b>			
1243-5	31-3/16"	210357	215319
1243-2	43-3/16"	210356	215320



This trim is best used to secure mats in places where more strength and longer ramps are required. Because this trim secures mats in place without using the lock lip, it enables easy mat removal and replacement.

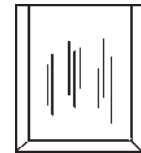

Single-Mat Installations

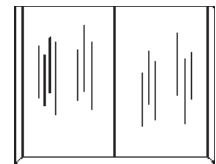

Side-by-Side Mat Installations

Threshold Kits are Sold Separately.

\*\* A portion of the tapered edge of these mats must be removed to utilize this trim.

## Trim Kits 2-1/2" Ramp Trim – Die #1714

		SINGLE MATS	SIDE-BY-SIDE MATS
MAT MODEL NUMBER	MAT LENGTH	TRIM KIT PART NUMBER	TRIM KIT PART NUMBER
<b>27-1/2" WIDTH</b>			
8151	56"	210946	215313
1659-1	56-1/4"	214132	215326
1204-1	57"	210346	211128
<b>28-7/8" WIDTH</b>			
1207-1	55-3/16"	210349	210758
<b>33-1/2" WIDTH</b>			
8154	56"	211220	215317
<b>34-3/4" WIDTH</b>			
1669-1	56-1/4"	214133	215327
<b>34-7/8" WIDTH</b>			
1237-1	55-3/16"	210352	213336
<b>36" WIDTH</b>			
3648	48"	233788	233791
<b>39-1/2" WIDTH</b>			
8157	56"	211226	212676
<b>40-3/16" WIDTH</b>			
1639-1	56-3/16"	211285	215322
<b>40-7/8" WIDTH</b>			
1243-1	55-3/16"	210355	215321
<b>48" WIDTH</b>			
4848	48"	233789	233792

Threshold Kits are Sold Separately.



This trim is best used to secure mats in places where more strength and longer ramps are required. Because this trim secures mats in place without using the lock lip, it enables easy mat removal and replacement.

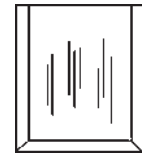

Single-Mat Installations

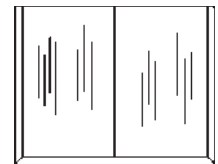

Side-by-Side Mat Installations

# Automatic Door Products Product List



The power of control. Automated.

## Trim Kits 2-1/2" Ramp Trim – Die #1814

		SINGLE MATS	SIDE-BY-SIDE MATS
MAT MODEL NUMBER	MAT LENGTH	TRIM KIT PART NUMBER	TRIM KIT PART NUMBER
<b>27-1/2" WIDTH</b>			
3030	27-1/2"	211930	215328
8153	32"	211934	215332
1204-5	32-1/2"	211931	215329
<b>28-7/8" WIDTH</b>			
3036	31-3/16"	211938	215334
1207-5	32-1/2"	211939	215335
<b>33-1/2" WIDTH</b>			
8156	32"	211943	215339
<b>34-7/8" WIDTH</b>			
1237-5	31-3/16"	211947	215342
<b>27-1/2" WIDTH</b>			
1204-2	43"	211932	215330
8152	44"	211935	213076
<b>28-7/8" WIDTH</b>			
3048	43-3/16"	211940	215336
1207-2	45-7/8"	211941	215337
<b>33-1/2" WIDTH</b>			
8155	44"	211944	215340
<b>34-7/8" WIDTH</b>			
1237-2	43-3/16"	211948	212281
<b>39-1/2" WIDTH</b>			
8158	44"	211950	215344
<b>40-7/8" WIDTH</b>			
	31-3/16"	211953	215346
	43-3/16"	211954	215347



This trim is best used to secure mats in places where more strength and longer ramps are required.

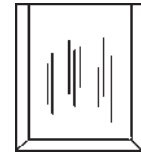

Single-Mat Installations

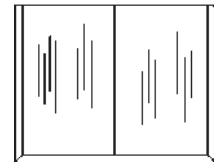

Side-by-Side Mat Installations

Threshold Kits are Sold Separately.



## Trim Kits 2-1/2" Ramp Trim – Die #1814

		SINGLE MATS	SIDE-BY-SIDE MATS
MAT MODEL NUMBER	MAT LENGTH	TRIM KIT PART NUMBER	TRIM KIT PART NUMBER
<b>27-1/2" WIDTH</b>			
8151	56"	211936	215333
1204-1	57"	211933	215331
<b>28-7/8" WIDTH</b>			
1207-1	55-3/16"	211942	215338
<b>33-1/2" WIDTH</b>			
8154	56"	211945	215341
<b>34-7/8" WIDTH</b>			
1237-1	55-3/16"	211949	215343
<b>36" WIDTH</b>			
3648	48"	218742	233543
<b>39-1/2" WIDTH</b>			
8157	56"	211951	215345
<b>40-7/8" WIDTH</b>			
1243-1	55-3/16"	214125	215348

Threshold Kits are Sold Separately.



This trim is best used to secure mats in places where more strength and longer ramps are required.

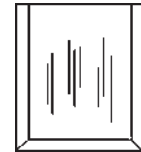

Single-Mat Installations

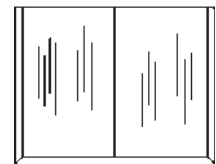

Side-by-Side Mat Installations

# Automatic Door Products Product List



The power of control. Automated.

## Trim Kits 2" Ramp Trim – Die #3311

		SINGLE MATS	SIDE-BY-SIDE MATS
MAT MODEL NUMBER	MAT LENGTH	TRIM KIT PART NUMBER	TRIM KIT PART NUMBER
<b>27-1/2" WIDTH</b>			
3030	27-1/2"	210392	215385
8153	32"	211209	215387
1204-5	32-1/2"	210336	215386
<b>28-7/8" WIDTH</b>			
3036	31-3/16"	210954	212727
1207-5	32-1/2"	210339	215388
<b>33-1/2" WIDTH</b>			
8156	32"	211213	215389
<b>34-7/8" WIDTH</b>			
1237-5	31-3/16"	210342	215390
<b>27-1/2" WIDTH</b>			
1204-2	43"	210335	211139
8152	44"	210948	211137
<b>28-7/8" WIDTH</b>			
3048	43-3/16"	210957	212726
1207-2	45-7/8"	210338	213037
<b>33-1/2" WIDTH</b>			
8155	44"	211216	213099
<b>34-7/8" WIDTH</b>			
1237-2	43-3/16"	210341	215391
<b>39-1/2" WIDTH</b>			
8158	44"	211222	215393
<b>40-7/8" WIDTH</b>			
1243-5	31-3/16"	210345	215395
1243-2	43-3/16"	210344	215396

Threshold Kits are Sold Separately.



The most popular trim option, this ramp is designed to eliminate trip hazards and works well in pedestrian traffic.

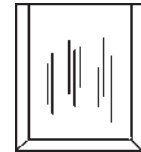

Single-Mat Installations

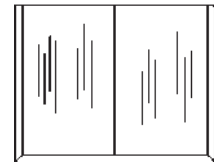

Side-by-Side Mat Installations

## Trim Kits 2" Ramp Trim – Die #3311

		SINGLE MATS	SIDE-BY-SIDE MATS
MAT MODEL NUMBER	MAT LENGTH	TRIM KIT PART NUMBER	TRIM KIT PART NUMBER
<b>27-1/2" WIDTH</b>			
8151	56"	210945	214624
1204-1	57"	210334	211141
<b>28-7/8" WIDTH</b>			
1207-1	55-3/16"	210337	213959
<b>33-1/2" WIDTH</b>			
8154	56"	211219	213410
<b>34-7/8" WIDTH</b>			
1237-1	55-3/16"	210340	215392
<b>36" WIDTH</b>			
3648	48"	233793	233796
<b>39-1/2" WIDTH</b>			
8157	56"	211225	215394
<b>40-7/8" WIDTH</b>			
1243-1	55-3/16"	210343	213958

Threshold Kits are Sold Separately.



The most popular trim option, this ramp is designed to eliminate trip hazards and works well in pedestrian traffic.

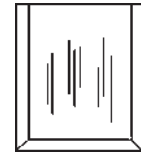

Single-Mat Installations

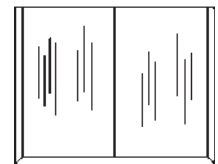

Side-by-Side Mat Installations

# Automatic Door Products Product List



The power of control. Automated.

## Trim Kits 2" Ramp Trim – Die #1049

		SINGLE MATS	SIDE-BY-SIDE MATS
MAT MODEL NUMBER	MAT LENGTH	TRIM KIT PART NUMBER	TRIM KIT PART NUMBER
<b>24-1/8" WIDTH</b>			
1224-5	36-9/16"	215511	215377
<b>27" WIDTH</b>			
1228-35	36"	211228	215373
<b>27-1/2" WIDTH</b>			
1606	33-3/8"	215510	215371
<b>28-1/8" WIDTH</b>			
1228-5	36-9/16"	215513	215379
<b>35" WIDTH</b>			
1236-35	36"	211229	215375
<b>36-1/8" WIDTH</b>			
1236-5	36-9/16"	215515	215381
<b>24-1/8" WIDTH</b>			
1224-2	45-9/16"	215512	215378
<b>27" WIDTH</b>			
1228-3	45"	211147	213492
<b>27-1/2" WIDTH</b>			
1605	44-3/4"	210757	211860
<b>28-1/8" WIDTH</b>			
1228-2	45-9/16"	215514	215380
<b>34-3/4" WIDTH</b>			
1636	44-3/4"	210969	215372
<b>35" WIDTH</b>			
1236-3	45"	211184	212968
<b>36-1/8" WIDTH</b>			
1236-2	45-9/16"	215516	215382

Threshold Kits are Sold Separately.



This trim option, designed for use with both tapered and beveled edge mats, is designed to eliminate trip hazards in normal pedestrian traffic.

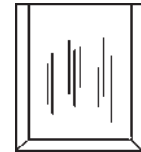

Single-Mat Installations

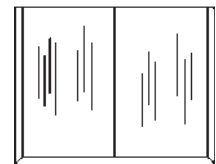

Side-by-Side Mat Installations

## Trim Kits 2" Ramp Trim – Die #1049

		SINGLE MATS	SIDE-BY-SIDE MATS
MAT MODEL NUMBER	MAT LENGTH	TRIM KIT PART NUMBER	TRIM KIT PART NUMBER
<b>27" WIDTH</b>			
1228-1	59"	211785	215374
<b>27-1/2" WIDTH</b>			
1659-1	56-1/4"	215517	215383
<b>34-3/4" WIDTH</b>			
1669-1	56-1/4"	215518	215384
<b>35" WIDTH</b>			
1236-1	59"	211230	215376
<b>40-3/16" WIDTH</b>			
1639-1	56-3/16"	215509	215370

Threshold Kits are Sold Separately.



This trim option, designed for use with both tapered and beveled edge mats, is designed to eliminate trip hazards in normal pedestrian traffic.

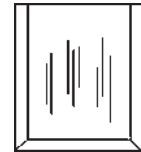

Single-Mat Installations

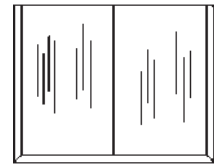

Side-by-Side Mat Installations

# Automatic Door Products Product List



The power of control. Automated.

## Trim Kits 3/4" Recessed Trim – Die #1057

		SINGLE MATS	SIDE-BY-SIDE MATS
MAT MODEL NUMBER	MAT LENGTH	TRIM KIT PART NUMBER	TRIM KIT PART NUMBER
<b>27-1/2" WIDTH</b>			
3030	27-1/2"	210944	215475
8153	32"	211212	215477
1204-5	32-1/2"	210360	213144
<b>28-7/8" WIDTH</b>			
3036	31-3/16"	210956	215478
1207-5	32-1/2"	210363	215479
<b>33-1/2" WIDTH</b>			
8156	32"	211215	215482
<b>34-7/8" WIDTH</b>			
1237-5	31-3/16"	210366	215483
<b>27-1/2" WIDTH</b>			
1204-2	43"	210359	211235
8152	44"	210950	213699
<b>28-7/8" WIDTH</b>			
3048	43-3/16"	210959	215480
1207-2	45-7/8"	210362	215491
<b>33-1/2" WIDTH</b>			
8155	44"	211218	212167
<b>34-7/8" WIDTH</b>			
1237-2	43-3/16"	210365	211435
<b>39-1/2" WIDTH</b>			
8158	44"	211224	213541
<b>40-7/8" WIDTH</b>			
1243-5	31-3/16"	210369	215485
1243-2	43-3/16"	210368	213401

Threshold Kits are Sold Separately;



This trim is used to secure mats in flush mount applications.

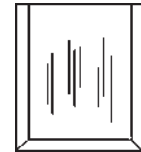

Single-Mat Installations

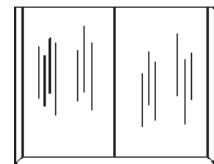

Side-by-Side Mat Installations

## Trim Kits 3/4" Recessed Trim – Die #1057

		SINGLE MATS	SIDE-BY-SIDE MATS
MAT MODEL NUMBER	MAT LENGTH	TRIM KIT PART NUMBER	TRIM KIT PART NUMBER
<b>27-1/2" WIDTH</b>			
8151	56"	210947	212320
1204-1	57"	210358	215476
<b>28-7/8" WIDTH</b>			
1207-1	55-3/16"	210361	215481
<b>33-1/2" WIDTH</b>			
8154	56"	211221	212731
<b>34-7/8" WIDTH</b>			
1237-1	55-3/16"	210364	213543
<b>36" WIDTH</b>			
3648	48"	234955	234954
<b>39-1/2" WIDTH</b>			
8157	56"	211227	215484
<b>40-7/8" WIDTH</b>			
1243-1	55-3/16"	210367	214878

Threshold Kits are Sold Separately;



This trim is used to secure mats in flush mount applications.

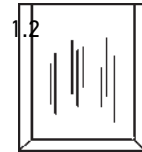

Single-Mat Installations

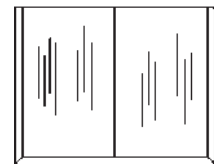

Side-by-Side Mat Installations



Threshold Kit and Joining Trim  
Installations with 1/2"-Thick Mats Used for Both Activation & Safety

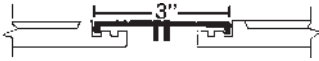

Trim #1048

LENGTH	PART NUMBER
30"	214216
31"	214246
36"	214328
37"	212070
42"	214329
43"	212071
48"	210418
49"	214330
60"	214331
62"	214332
72"	214333
74"	214334
84"	214335
86"	214336
96"	214337
98"	214338

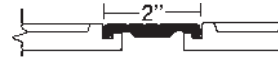

Trim #200

LENGTH	PART NUMBER
30"	214357
31"	214358
36"	214359
37"	214360
42"	214361
43"	214362
48"	214363
49"	214364
60"	214365
62"	214366
72"	214367
74"	214368
84"	214369
86"	214370
96"	214371
98"	214372

Installations with 3/8"-Thick Mats Used for Both Activation & Safety



Trim #1510 and #1515

LENGTH	PART NUMBER
28-1/2"	211158
36-1/2"	211157
57"	214389
73"	214390

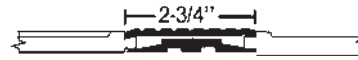

Trim #1530 and #1535

LENGTH	PART NUMBER
28-1/2"	211160
36-1/2"	211159
57"	214355
73"	214356

## Threshold Kit and Joining Trim Installations with 1/2"-Thick Mats Used for Safety Only

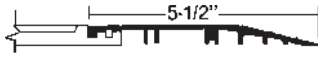

Trim #1048 and #1250

LENGTH	PART NUMBER
30"	214339
31"	214340
36"	214341
37"	214342
42"	214343
43"	214344
48"	214345
49"	214346
60"	214347
62"	214348
72"	214349
74"	214350
84"	214351
86"	214352
96"	214353
98"	214354



Trim #200 and #1250

LENGTH	PART NUMBER
30"	214373
31"	214374
36"	214375
37"	214376
42"	214377
43"	214378
48"	214379
49"	214380
60"	214381
62"	214382
72"	214383
74"	214384
84"	214385
86"	214386
96"	214387
98"	214388

# Guide Rails

## Safety Components for Automatic Doors

Larco guide rails provide added protection and stability to your automatic door installation, combining durability and eye-appealing good looks. Required for ANSI compliance in most swinging doors and folding doors, guide rails prevent accidents and direct traffic flow through the door. They provide a point of stability for pedestrians entering and exiting. Larco guide rails are made of an attractive and durable anodized aluminum, which means you will benefit from a good-looking guide rail designed to last.

### Options

#### Material and Construction

Standard Larco guide rails and glass guards are constructed of 1.5" x 0.5" anodized aluminum extrusion. Optional heavy duty rails using 1.75" x 0.5" extrusion are available in most guide rail styles. Add 25% for heavy duty rails. Specify **heavy duty** when ordering.

All guide rails include heavy duty solid aluminum rail feet and all necessary mounting hardware crafted of stainless steel to protect against rusting and corrosion. For enhanced stability, the guide rail's leg can be extended 6 inches below its mounting feet for core drilling. The standard radius on curved rails is 6 inches.

#### Colors

Larco guide rails come standard with a clear or dark bronze finish. Other finishes are available upon request.

#### Panels

Larco offers a variety of panels and inserts. The standard panel is constructed of 1/4" black impact resistant material. Additional colors available include red, white and blue. Mesh panels also are available in mill finish and powder coat bronze.

#### Non-Standard Rails

Special rails or guards of any length, height or shape are available upon request, including vestibule dividers, cart corrals, etc. Guide rail/remote post combinations also are available.

Customers may specify optional modifications to any or our standard guide rails, such as adding panels, mesh, horizontal/vertical bars or push plate switch cutouts. Add these options on to the base price of the rail to calculate the total. For additional options, contact us for pricing.

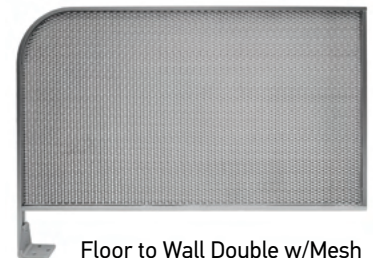

Floor to Wall Double w/Mesh

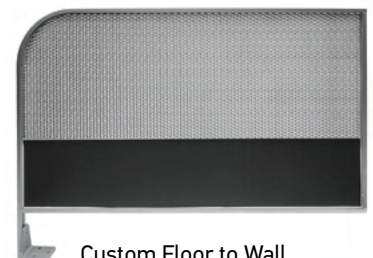

Custom Floor to Wall w/Mesh and Panel

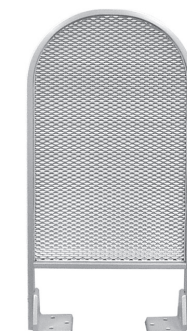

Custom Floor to Floor w/Mesh (for Bi-Fold Doors)

 **WARNING:** Cancer and Reproductive Harm - [www.P65Warnings.ca.gov](http://www.P65Warnings.ca.gov)

## Aluminum Guide Rails Ordering Information, Dimensions & Details

DESCRIPTION/DETAIL	PART NUMBER	SIZE (H" X L")
Floor to Wall Double	225423*	30" x 24"
	222126*	30" x 30"
	227713*	30" x 36"
	214398*	30" x 42"
	215155	30" x 48"
	230707*	36" x 24"
	219995*	36" x 30"
	219439*	36" x 36"
	214399*	36" x 42"
	215629	36" x 48"
Floor to Wall Double w/Mesh	214400*	30" x 42"
	214401*	36" x 42"
Floor to Wall Double w/Mesh & Vertical Support	214402*	30" x 42"
	214403*	36" x 42"
Floor to Wall Double w/Mesh & Vertical & Horizontal Support	214404*	30" x 42"
	214405*	36" x 42"
Floor to Wall Double w/Panel	214406*	30" x 42"
	214407*	36" x 42"
Heavy Duty Floor to Wall Double w/ Channel for Holding Beam**	211583*	30" x 42"
	211584	30" x 48"
Heavy Duty Floor to Wall Double w/ Channel for Holding Beam**	211636*	30" x 42"
	211637	30" x 48"
Heavy Duty Floor to Wall Double w/ Panel & Wall Switch Cutout**	212310	42" x 48"
	212311	42" x 60"
Floor to Floor Double	221843*	30" x 24"
	219724*	30" x 30"
	219069*	30" x 36"
	216260*	30" x 42"
	225461	30" x 48"
	232007*	36" x 24"
	230845*	36" x 30"
	220844*	36" x 36"
	216387*	36" x 42"
	219438	36" x 48"



Floor to Wall Double

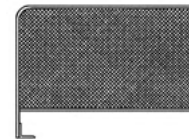

Floor to Wall Double w/Mesh

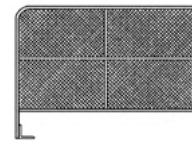

Floor to Wall Double w/Mesh & Supports

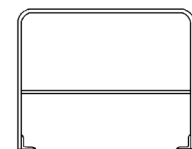

Floor to Floor Double



Floor to Wall Double w/Panel & Push Plate Switch Cutout (switch sold separately)

\* Indicates guide rails that can be shipped via UPS. \*\*Specify whether right or left hand guide rails when placing your order.

## Aluminum Guide Rails Installation Accessories

DESCRIPTION	CLEAR	BRONZE
	PART NUMBER	PART NUMBER
Guide Rail Foot	21139900	21139913
Expansion Anchor (attaches foot to floor)	211475	
Pressnut (attaches foot to rail)	211474	
10-24 x 1" Screw (thread cutting for rail joint)	21147700	21147713
5/16"-18 x 3/4" Screw (attaches foot to rail)	21147600	21147613

## Stock Length Guide Rail Extrusion

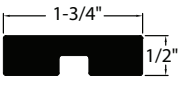
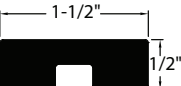
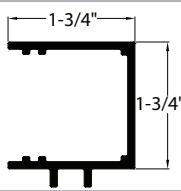
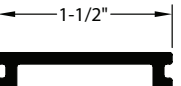
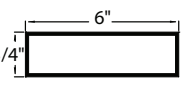
DESCRIPTION/DIE	DETAIL	CLEAR	BRONZE
		PART NUMBER	PART NUMBER
Heavy Duty Guide Rail Die #4116 (174")		21160810	21160813
Standard Guide Rail Die #2675 (174")		21404500	21404513
Guide Rail Holding Beam Channel Die #510 (145")		21182410	21182413
Holding Beam Channel Cover Die #530 (145")		21182310	21182313
Wall Switch Tube (144")		21529010	21529013

## Glass Guards/Push Bars

DESCRIPTION	CLEAR	BRONZE
	PART NUMBER	PART NUMBER
Glass Guard for 36" Door - 22" Height	21203300	21203313
Glass Guard for 36" Door - 40" Height	21203500	21203513
Glass Guard for 42" Door - 22" Height	21203400	21203413
Glass Guard for 42" Door - 40" Height	21203600	21203613
36" Push Bar	21623000	21623013
42" Push Bar	21662700	21662713
48" Push Bar	33801900	33801913
1/4"-20 x 1" Screw*	21204500	21204513
1/4"-20 x 1-1/2" Screw*	21204400	21204413

\*Thread Cutting for Glass Guard Assembly

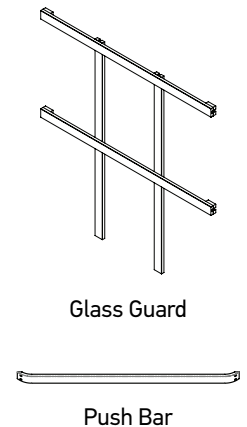

## Stainless Steel Posts and Guide Rails

DESCRIPTION	PART NUMBER
<b>STAINLESS STEEL REMOTE POSTS - 40" H</b>	
Round Post, 4½" Plate, Core Mount (mirror)	4033811300
Round Post, 4½" Plate, Core Mount (satin)	4033811331
Round Post, 4½" Plate, Core Mount (bronze)	4033811313
Round Post, 4½" Plate, Core Mount (black)	4033811311
Round Post, 4½" Plate, Surface Mount (mirror)	4033811400
Round Post, 4½" Plate, Surface Mount (satin)	4033811431
Round Post, 4½" Plate, Surface Mount (bronze)	4033811413
Round Post, 4½" Plate, Surface Mount (black)	4033811411
<b>GUIDE RAILS 30"-36" H X 42" L – CUSTOM SIZES ARE AVAILABLE.</b>	
FFD Guide Rail, Core Mount (mirror)	FFDCMR
FFD Guide Rail, Core Mount (satin)	FFDCSA
FFD Guide Rail, Core Mount (bronze)	FFDCBR
FFD Guide Rail, Core Mount (black)	FFDCBL
FFD Guide Rail, Surface Mount (mirror)	FFDSMR
FFD Guide Rail, Surface Mount (satin)	FFDSSA
FFD Guide Rail, Surface Mount (bronze)	FFDSBR
FFD Guide Rail, Surface Mount (black)	FFDSBL
FFD Guide Rail, 1 Curve, Core Mount (mirror)	FFDC1BMR
FFD Guide Rail, 1 Curve, Core Mount (satin)	FFDC1BSA
FFD Guide Rail, 1 Curve, Core Mount (bronze)	FFDC1BBR
FFD Guide Rail, 1 Curve, Core Mount (black)	FFDC1BBL
FFD Guide Rail, 1 Curve, Surface Mount (mirror)	FFDS1BMR
FFD Guide Rail, 1 Curve, Surface Mount (satin)	FFDS1BSA
FFD Guide Rail, 1 Curve, Surface Mount (bronze)	FFDS1BBR
FFD Guide Rail, 1 Curve, Surface Mount (black)	FFDS1BBL
FWD Guide Rail, Core Mount (mirror)	FWDCMR
FWD Guide Rail, Core Mount (satin)	FWDCSA
FWD Guide Rail, Core Mount (bronze)	FWDCBR
FWD Guide Rail, Core Mount (black)	FWDCBL
FWD Guide Rail, Surface Mount (mirror)	FWDSMR
FWD Guide Rail, Surface Mount (satin)	FWDSSA
FWD Guide Rail, Surface Mount (bronze)	FWDSBR
FWD Guide Rail, Surface Mount (black)	FWDSBL

\*Additional options available – contact us.



Post Assembly Only  
(switch not included)



Floor to Floor

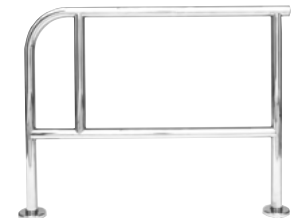

Floor to Floor Double



Floor to Wall Double

## Guide Rails with Remote Posts

DESCRIPTION	PART NUMBER
<b>SWWD GUIDE RAIL WITH REMOTE POST</b>	
Hardwired - SWWD 36.5" x 48" Post Assembly Double Top Bar for Hardwire	235710
433 MHz - SWWD 36" x 48" Post Assembly Single Top Bar for Radio Controlled Transmitter	234987

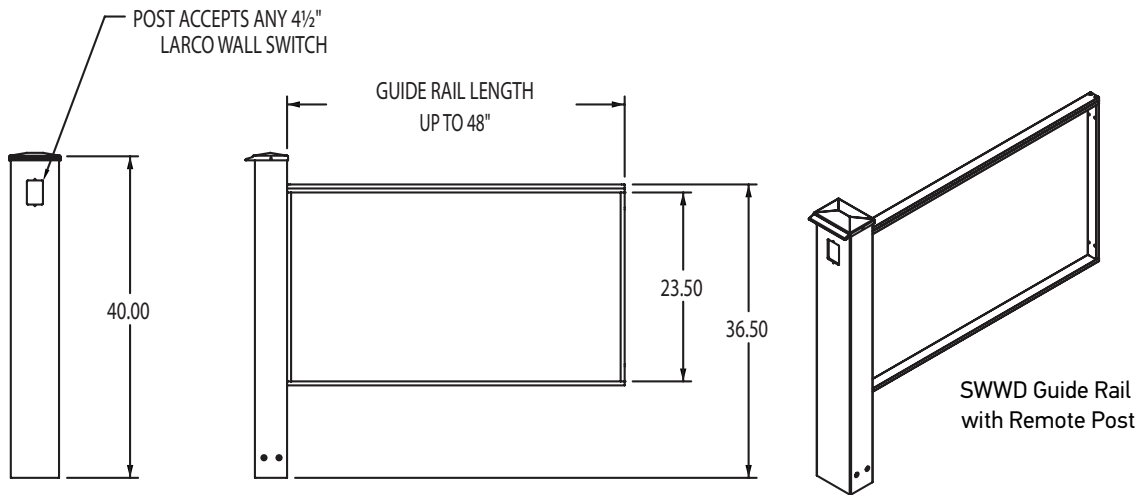

DESCRIPTION	PART NUMBER
<b>SWWDS GUIDE RAIL WITH SUPPORT LEG &amp; REMOTE POST</b>	
Hardwired - SWWDS 36.5" x 60" Post Assembly Double Top Bar for Hardwire with Support Leg	338824
433 MHz - SWWDS 36.5" x 60" Post Assembly Single Top Bar for Radio Controlled Transmitter, with Support Post	341171

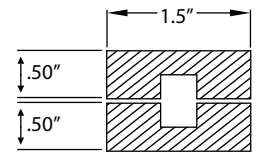

Double Top Bars for Hardware Applications

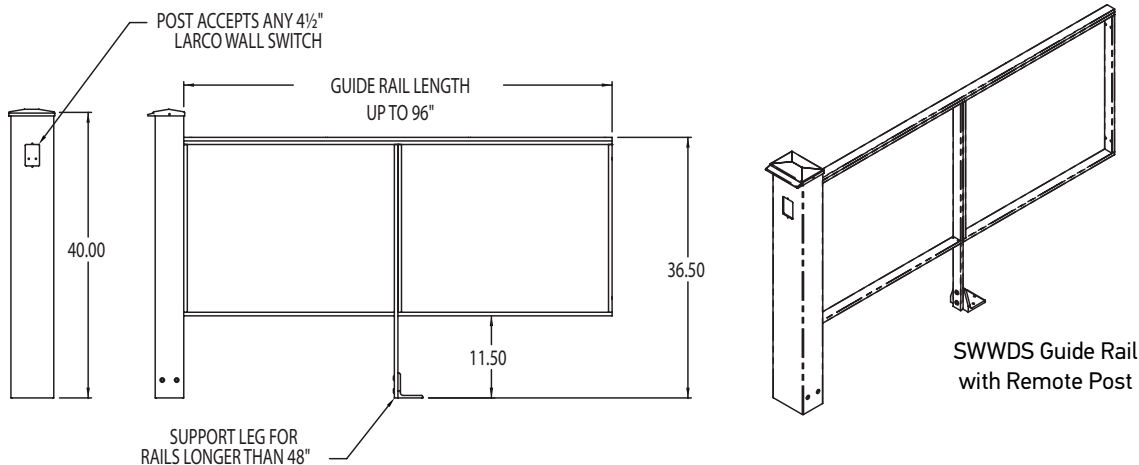



## Remote Post Assemblies

Larco remote post assemblies can accommodate any of our push plate switches. Made from a top-quality finished aluminum, they are designed to stand up to tough weather environments.

### Remote Post Options

**Color:** Remote posts are standard in powder coat clear and dark bronze. Other colors are available; contact us for pricing. All posts also can be supplied in mill finish and shipped directly to your finisher for color matching.

**Size:** The standard size for remote posts is 4" x 6" x 40". Longer lengths for core mounting or custom applications are available up to 120 inches.

**Alternate Device Cutouts:** Larco remote posts can accommodate many different types of access devices, including biometrics, card readers, badge readers, key switches, etc. Contact us for pricing.

**Alternate Configurations:** Remote posts can be combined with guide rails to provide a secure method of mounting security devices. Contact us for more information.



DESCRIPTION	PART NUMBER
Silver (Clear) Powder Coat Assembly Hardwired without Transmitter	23498700
Bronze Painted Post Assembly without Hardwire Transmitter	23498713
Silver (clear) Powder Coat Post Assembly with 300 MHz Wireless Transmitter*	23498800
Bronze Powder Coat Post Assembly with 300 MHz Wireless Transmitter*	23498813
Silver (clear) Powder Coat Post Assembly with 433 MHz Wireless Transmitter*	23498900
Bronze Powder Coat Post Assembly with 433 MHz Wireless Transmitter*	23498913
Replacement Cap	21831200
Replacement Cap with 300 MHz Radio-Control Transmitter*	23174900
Replacement Cap with 433 MHz Wireless Transmitter*	23458700

\* Receivers are Sold Separately.

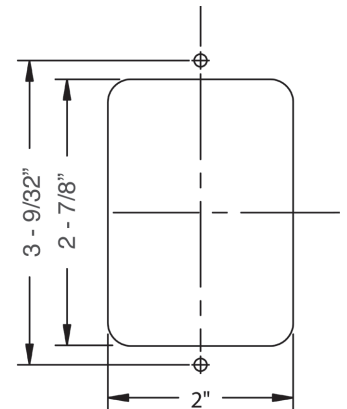

Push Plate Switch Cutout Detail for Remote Post Assembly

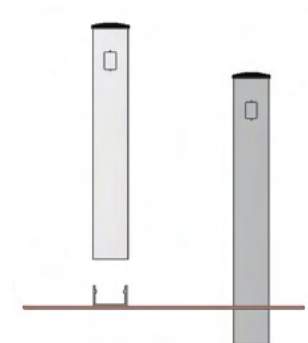

Surface Mount      Core Mount

# Push Plate Switches

## Durable Mounting Solutions for Tough Environments

Larco push plate switches include a unique adapter plate (at no additional charge) that is intended for use with Larco universal mounting boxes, as well as standard size 2" x 4" and 4" x 4" electrical boxes. The slim-profile adapter plate cradles the switch, preventing access to the rear of the switch and protecting the switch's internal components from weather conditions, which makes Larco already durable and dependable switches even more vandal and weather resistant.



### Switch Options

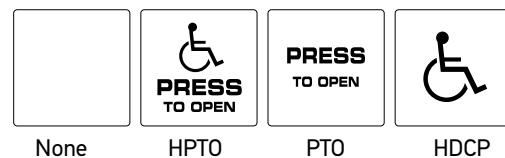

- 1 Material**  
The standard finish is brushed 304 stainless steel.
- 2 Weatherproofing**  
Although the standard Larco push plate switch is suitable for outdoor use, switches treated with a weather-resistant material are available for extremely wet applications. Add "W" to the front of your part number.



- 3 Standard Engravings**  
Larco 4-1/2", 6" switches and jamb switches are available with the standard engravings shown. Custom engravings, such as right and left arrows, special messages, symbols, and foreign languages can be made to order. Contact us for details.
- 4 Ordering Information**  
Push plate switches can be configured in a number of ways. You may purchase switches alone for mounting to a standard electrical box or purchase a push plate switch and Larco box package for use in hardwired or radio-controlled installations. These can surface mount or recess mount with the same box.

 **WARNING:** Cancer and Reproductive Harm - [www.P65Warnings.ca.gov](http://www.P65Warnings.ca.gov)

### Stainless Steel Hardwired Push Plate Switches

DETAIL	SIZE	SHAPE	ENGRAVING	PART NUMBER
	6" *	Square	None HPTO PTO HDCP	6S0 6S1 6S2 6S3
	6" *	Round	None HPTO PTO HDCP	6R0A 6R1A 6R2A 6R3A
	6" *	Round	None HPTO PTO HDCP	6R0 6R1 6R2 6R3
	4 1/2" *	Square	None HPTO PTO HDCP	4S0 4S1 4S2 4S3
	4 1/2" *	Round	None HPTO PTO HDCP	4R0A 4R1A 4R2A 4R3A
	4 1/2" *	Round	None HPTO PTO HDCP	4R0 4R1 4R2 4R3
DETAIL	SIZE	COMMENT	ENGRAVING	PART NUMBER
	Jamb Switch	N/A	None HPTO PTO HDCP Right Arrow Left Arrow	J00 J01 J02 J03 J04 J05
	For Use with a Transmitter		None HPTO PTO HDCP	J00TX J01TX J02TX J03TX
	Small Red Jamb Switch	N/A	N/A	215094

Larco square or round hardwired Push Plate Switches are designed for universal mounting in any standard box, including single-gang (2" x 4") and double-gang (4" x 4") wall boxes.

Jamb Switch only. Box not included.

Note: Switch will not fit in a standard single gang box.

\* An optional stainless steel protection plate can be ordered separately for 6" switches (P/N: 228287) and 4 1/2" switches (P/N: 218070) See details on page 65.

\*\* Jamb switches can be mounted in jamb switch boxes.

## Box Assemblies with Stainless Steel Push Plate Switches

SIZE	SHAPE	OPERATION METHOD	ENGRAVING	UNIVERSAL BOX	ROUND
				PART NUMBER	PART NUMBER
6"	Square 	Hardwired 300 MHz 433 MHz	None	6S0U0 6S0U3 6S0U4	
		Hardwired 300 MHz 433 MHz	HPTO	6S1U0 6S1U3 6S1U4	
		Hardwired 300 MHz 433 MHz	PTO	6S2U0 6S2U3 6S2U4	
		Hardwired 300 MHz 433 MHz	HDCP	6S3U0 6S3U3 6S3U4	
6"	Round  	Hardwired 300 MHz 433 MHz	None	6R0U0 6R0U3 6R0U4	6R0R0  6R0R4
		Hardwired 300 MHz 433 MHz	HPTO	6R1U0 6R1U3 6R1U4	6R1R0  6R1R4
		Hardwired 300 MHz 433 MHz	PTO	6R2U0 6R2U3 6R2U4	6R2R0  6R2R4
		Hardwired 300 MHz 433 MHz	HDCP	6R3U0 6R3U3 6R3U4	6R3R0  6R3R4
4½"	Square 	Hardwired 300 MHz 433 MHz	None	4S0U0 4S0U3 4S0U4	
		Hardwired 300 MHz 433 MHz	HPTO	4S1U0 4S1U3 4S1U4	
		Hardwired 300 MHz 433 MHz	PTO	4S2U0 4S2U3 4S2U4	
		Hardwired 300 MHz 433 MHz	HDCP	4S3U0 4S3U3 4S3U4	
4½"	Round  	Hardwired 300 MHz 433 MHz	None	4R0U0 4R0U3 4R0U4	4R0R0  4R0R4
		Hardwired 300 MHz 433 MHz	HPTO	4R1U0 4R1U3 4R1U4	4R1R0  4R1R4
		Hardwired 300 MHz 433 MHz	PTO	4R2U0 4R2U3 4R2U4	4R2R0  4R2R4
		Hardwired 300 MHz 433 MHz	HDCP	4R3U0 4R3U3 4R3U4	4R3R0  4R3R4

Larco universal and round box push plate switch assemblies come complete with switch, mounting box and your choice of hardwired or radio-controlled operation with a 300 MHz or 433 MHz transmitter.

Receivers are sold separately; See page 66 for details. Boxes may be flush mounted using the flush mount kit sold separately on page 64.

Backlit LED Push Plate Switches

Stainless Steel

SIZE	SHAPE/ SWITCH BOX	ENGRAVING	PART NUMBER
6" LED	Square/ Universal	None	6S0U0LED
		HPTO	6S1U0LED
		PTO	6S2U0LED
		HDCP	6S3U0LED
	Round/Universal	None	6R0U0LED
		HPTO	6R1U0LED
		PTO	6R2U0LED
		HDCP	6R3U0LED
	Round/Round	None	6R0R0LED
		HPTO	6R1R0LED
		PTO	6R2R0LED
		HDCP	6R3R0LED
4½" LED	Square/ Universal	None	4S0U0LED
		HPTO	4S1U0LED
		PTO	4S2U0LED
		HDCP	4S3U0LED
	Round/Universal	None	4R0U0LED
		HPTO	4R1U0LED
		PTO	4R2U0LED
		HDCP	4R3U0LED
	Round/Round	None	4R0R0LED
		HPTO	4R1R0LED
		PTO	4R2R0LED
		HDCP	4R3R0LED

The Blue Diamond line of LED switches feature blue backlighting for greater visibility and safety.



## Stainless Steel Jamb Switches with Mounting Boxes

### Individual Jamb Switch Mounting Boxes

DESCRIPTION	PART NUMBER
Jamb Switch Box only - No Transmitter	JJ0
Jamb Switch Box with 433 MHz Transmitter	JJ4
Jamb Switch Box with Switch (no engraving) - No Transmitter	J00J0
Jamb Switch Box with Switch (no engraving) and 433 MHz Transmitter	J00J4
Jamb Switch Box with Switch (HPT0 engraving) - No Transmitter	J01J0
Jamb Switch Box with Switch (HPT0 engraving) and 433 MHz Transmitter	J01J4
Jamb Switch Box with Switch (PT0 engraving) - No Transmitter	J02J0
Jamb Switch Box with Switch (PT0 engraving) and 433 MHz Transmitter	J02J4
Jamb Switch Box with Switch (HDCP engraving) - No Transmitter	J03J0
Jamb Switch Box with Switch (HDCP engraving) and 433 MHz Transmitter	J03J4

Low profile 1-3/4" deep by 4-3/4" mounting box is made of high-impact ABS for durability. Jamb switch boxes can be sold alone, with a 433 MHz transmitter, or as part of a jamb switch assembly.



Jamb switch boxes with and without jamb switch

### Individual Jamb Switch Packages

DESCRIPTION	PART NUMBER
<b>JAMB SWITCHES WITH BOX AND TRANSMITTER</b>	
(2) Jamb Switches (blank) with Boxes and (2) Transmitters (1) Receiver, 433 MHz	PJ00
(2) Jamb Switches "HPT0" with Boxes and (2) Transmitters (1) Receiver, 433 MHz	PJ01
(2) Jamb Switches "PT0" with Boxes and (2) Transmitters (1) Receiver, 433 MHz	PJ02
(2) Jamb Switches "Handicap" with Boxes and (2) Transmitters (1) Receiver, 433 MHz	PJ03

Order a combination of jamb switches, transmitters and receivers for your jobs, using one part number.

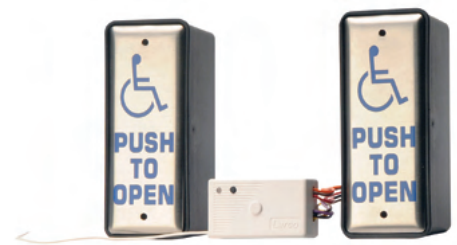

PJ01 Package

## Jamb Switch Packages

DESCRIPTION	PART NUMBER
<b>JAMB SWITCHES WITH UNIVERSAL BOX</b>	
(2) Jamb Switches "HPTO" LH-RH Arrows and 6" Box - No Transmitter	6J45U0
(2) Jamb Switches "PTO" LH-RH Arrows and 6" Box - No Transmitter	6J67U0
<b>JAMB SWITCHES WITH UNIVERSAL BOX AND TRANSMITTER</b>	
(2) Jamb Switches "HPTO" LH-RH Arrows and 6" Box with Transmitter 433 MHz	6J45U4
(2) Jamb Switches "PTO" LH-RH Arrows and 6" Box with Transmitter 433 MHz	6J67U4
(2) Jamb Switches "HPTO" LH-RH Arrows and 4½" Box with Transmitter 433 MHz	4J45U4
(2) Jamb Switches "PTO" LH-RH Arrows and 4½" Box with Transmitter 433 MHz	4J67U4



4J45U0



## Push Plate Switch Packages

Order a combination of push plate switches, transmitters and receivers for jobs using one part number.

DESCRIPTION	PART NUMBER
<b>6" SWITCH PACKAGES</b>	
(2) 6" Square "HPTO" with Transmitter, Boxes & (1) Receiver 433 MHz	P6S1
(2) 6" Round "HPTO" with Transmitter, Boxes & (1) Receiver 433 MHz	P6R1
(2) 6" Square "PTO" with (2) Transmitters, Boxes & (1) Receiver 433 MHz	P6S2
(2) 6" Round "PTO" with (2) Transmitters, Boxes & (1) Receiver 433 MHz	P6R2
(2) 6" Square "HDCP" (2) Transmitters, Boxes & (1) Receiver 433 MHz	P6S3
(2) 6" Round "HDCP" (2) Transmitters, Boxes & (1) Receiver 433 MHz	P6R3
(2) 6" Square "HPTO" Switches w/Universal Box - No Transmitter	P6S1U0
(2) 6" Round "HPTO" Switches w/Universal Box - No Transmitter	P6R1U0
<b>4½" SWITCH PACKAGES</b>	
(2) 4½" Square "HPTO" with Transmitter, Boxes & (1) Receiver 433 MHz	P4S1
(2) 4½" Round "HPTO" with Transmitter, Boxes & (1) Receiver 433 MHz	P4R1
(2) 4½" Square "PTO" with (2) Transmitters, Boxes & (1) Receiver 433 MHz	P4S2
(2) 4½" Round "PTO" with (2) Transmitters, Boxes & (1) Receiver 433 MHz	P4R2
(2) 4½" Square "HDCP" (2) Transmitters, Boxes & (1) Receiver 433 MHz	P4S3
(2) 4½" Round "HDCP" (2) Transmitters, Boxes & (1) Receiver 433 MHz	P4R3
(2) 4½" Square "HPTO" Switches w/Universal Box - No Transmitter	P4S1U0
(2) 4½" Round "HPTO" Switches w/Universal Box - No Transmitter	P4R1U0
(2) 4½" Square "PTO" Switches w/Universal Box - No Transmitter	P4S2U0
(2) 4½" Round "PTO" Switches w/Universal Box - No Transmitter	P4R2U0
(2) 4½" Square "HDCP" Switches w/Universal Box - No Transmitter	P4S3U0
(2) 4½" Round "HDCP" Switches w/Universal Box - No Transmitter	P4R3U0



P4S1 Package



P4S1U0 Package

### Push Plate Switch Packages

Order a combination of push plate switches, transmitters and receivers for jobs using one part number.

DESCRIPTION	PART NUMBER
<b>6" PUSH PLATE SWITCH PACKAGES</b>	
(2) 6" Square "HPTO", (2) Jamb Switch "HPTO" LH-RH Arrows, Boxes, (4) Transmitters & (2) Receivers 433 MHz	P6S1J45U4
(2) 6" Round "HPTO", (2) Jamb Switch "HPTO" LH-RH Arrows, Boxes, (4) Transmitters & (2) Receivers 433 MHz	P6R1J45U4
(2) 6" Square "HPTO", (2) Jamb Switch "HPTO" LH-RH Arrows, Boxes, (4) Transmitters & (2) Sequencers 433 MHz	P6S1J45U4S
(2) 6" Round "HPTO", (2) Jamb Switch "HPTO" LH-RH Arrows, Boxes, (4) Transmitters & (2) Sequencers 433 MHz	P6R1J45U4S
(2) 6" Square "PTO", (2) Jamb Switch "PTO" LH-RH Arrows, Boxes, (4) Transmitters & (2) Receivers 433 MHz	P6S2J67U4
(2) 6" Round "PTO", (2) Jamb Switch "PTO" LH-RH Arrows, Boxes, (4) Transmitters & (2) Receivers 433 MHz	P6R2J67U4
(2) 6" Square "PTO", (2) Jamb Switch "PTO" LH-RH Arrows, Boxes, (4) Transmitters & (2) Sequencers 433 MHz	P6S2J67U4S
(2) 6" Round "PTO", (2) Jamb Switch "PTO" LH-RH Arrows, Boxes, (4) Transmitters & (2) Sequencers 433 MHz	P6R2J67U4S
<b>4½" PUSH PLATE SWITCH PACKAGES</b>	
(2) 4½" Square "HPTO", (2) Jamb Switches "HPTO" LH-RH Arrows, Boxes, (4) Transmitters & (2) Receivers 433 MHz	P4S1J45U4
(2) 4½" Round "HPTO", (2) Jamb Switch "HPTO" LH-RH Arrows, Boxes, (4) Transmitters & (2) Receivers 433 MHz	P4R1J45U4
(2) 4½" Square "HPTO", (2) Jamb Switch "HPTO" LH-RH Arrows, Boxes, (4) Transmitters & (2) Sequencers 433 MHz	P4S1J45U4S
(2) 4½" Round "HPTO", (2) Jamb Switch "HPTO" LH-RH Arrows, Boxes, (4) Transmitters & (2) Sequencers 433 MHz	P4R1J45U4S
(2) 4½" Square "PTO", (2) Jamb Switch "PTO" LH-RH Arrows, Boxes, (4) Transmitters & (2) Receivers 433 MHz	P4S2J67U4
(2) 4½" Round "PTO", (2) Jamb Switch "PTO" LH-RH Arrows, Boxes, (4) Transmitters & (2) Receivers 433 MHz	P4R2J67U4
(2) 4½" Square "PTO", (2) Jamb Switch "PTO" LH-RH Arrows, Boxes, (4) Transmitters & (2) Sequencers 433 MHz	P4S2J67U4S
(2) 4½" Round "PTO", (2) Jamb Switch "PTO" LH-RH Arrows, Boxes, (4) Transmitters & (2) Sequencers 433 MHz	P4R2J67U4S



### HandiTap Vertical Push Plate Switches

DESCRIPTION	ENGRAVING	PART NUMBER
36" Vertical Push Plate Switch (clear anodized)	HPTO	36V1N00
36" Vertical Push Plate Switch with 433 MHz Transmitter (clear anodized)		36V1N400
9" Vertical Push Plate Switch (clear anodized)	HPTO	9V1N00
9" Vertical Push Plate Switch with 433 MHz Transmitter (clear anodized)		9V1N400



The low-profile, rounded shape of the 4" wide HandiTap vertical switch makes it ideal for wall or post mounting. Its anodized aluminum construction and sloped caps provide a rugged, weather-resistant solution for automatic door applications.



### U-WAV Touchless Switches

DESCRIPTION	COLOR	PART NUMBER
U-WAV Touchless Switch	Gray	33681700
	Black	33681711
	White	33681720



The U-WAV touch free switch features always on, blue LED backlighting. Just a wave of your hand in front of the plate, activates the switch to open an automatic door or turn on lights. Fits a standard single gang electrical box - indoor use only.

## Universal Mounting Boxes

DESCRIPTION	PART NUMBER
6" Universal Box - No Transmitter	6U0
6" Universal Box with 300 MHz Transmitter	6U3
6" Universal Box with 433 MHz Transmitter	6U4
6" Universal Box Flush Kit	6UFK
4½" Universal Box without Transmitter	4U0
4½" Universal Box with 300 MHz Transmitter	4U3
4½" Universal Box with 433 MHz Transmitter	4U4
4½" Universal Box Flush Kit	4UFK

Low profile 1-3/4" deep square mounting boxes are made of high-impact ABS for durability. Designed to mount both square and round switches in surface- and flush-mount applications. Flush mount kit sold separately.



6" Universal Box

Flush Kit Ring

## Round Mounting Boxes

DESCRIPTION	PART NUMBER
6" Round Box - No Transmitter	600R0
6" Round Box with 433 MHz Transmitter	600R4
6" Round Box Flush Kit	6RFK
4½" Round Box - No Transmitter	400R0
4½" Round Box with 433 MHz Transmitter	400R4
4½" Round Box Flush Kit	4RFK

Designed for use with 6" and 4½" universal push plate switch mounting boxes. Kit includes ring, metal bracket and fasteners required for flush mounting.



4½" Round Box

6" Round Box with Transmitter

## Utility Mounting Boxes

DESCRIPTION	PART NUMBER
Utility Box - No Transmitter	4T0
Utility Box with 433 MHz Transmitter	4T4
Utility Box with 300 MHz Transmitter	4T3

4" x 4" PVC box has 3/16"-thick walls for extreme durability. Depth of box is 2-1/8" and fits both 6" and 4½" switches.

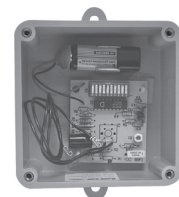

Utility Box with 300 MHz Transmitter

## Push Plate Switch Accessories

### Dress Wall Protector Plate

DETAIL	DESCRIPTION	PART NUMBER
	Protector Plate for 6" Switch	228287
	Protector Plate for 4½" Switch	218070

Protects mounting surface behind switch when mounting box is not used. Designed for high traffic, high impact operations are expected, such as hospitals, schools and shopping malls.



228287



218070

### Replacement Snap Action Switches

DETAIL	DESCRIPTION	PART NUMBER
	Single Pole, Single Throw Switch for All Larco Switches	212219
	Double Pole, Double Throw for All Larco Switches and Can be Used to Operate Two Different Devices Simultaneously	218481
	Switch Weatherproofing (optional)	Add "W" Prefix to P/N



212219



218481

### Replacement Adapter Plates and Flush Mount Accessories

DESCRIPTION	PART NUMBER
Adapter Plate 6" Square Push Plate Switch for Universal Box	232315
Adapter Plate 6" Round Push Plate Switch for Universal Box	232316
Adapter Plate 6" Round for Round Box	339613
Adapter Plate 6" Round Clear for Round Box	3396131
Adapter Plate 4½" Square Push Plate Switch for Universal Box	232481
Adapter Plate 4½" Round Push Plate Switch for Universal Box	232483
Adapter Plate 4½" Round for Round Box	339609
Adapter Plate 4½" Round Clear for Round Box	3396091
Dual Jamb 6" Adapter Plate Kit	339155
Dual Jamb 4½" Adapter Plate Kit	338869
Flush Mount Ring 6" for Universal Box	232314
Flush Mount Ring 6" for Round Box	232614
Flush Mount Ring 4½" for Universal Box	232482
Flush Mount Ring 4½" Round	339610
Flush Retaining Bracket 6" for Universal Box	232313
Flush Retaining Bracket 4½" for Universal Box	232484
Adapter Ring 4" Square (used in 4½" & 6")	220069

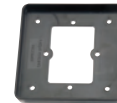

4½" Universal Box  
Square Adapter  
Plate

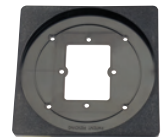

6" Universal Box  
Round Adapter  
Plate

# Receivers & Transmitters

## Receivers

DETAIL	DESCRIPTION	PART NUMBER
	Ultra-small 433 MHz Receiver (shown)	233804
	Ultra-small 433 MHz Vestibule Sequencer	235215
	Universal Receiver 300 MHz, One-channel (not shown)	339386
	Universal Receiver 300 MHz, Two-channel (not shown)	339387

NOTE: Larco Ultra-Small receivers are not compatible with any 300 MHz transmitter/receiver products.

Larco Ultra-small receivers are self-learning (programmable) and can learn up to 112 separate transmitter codes. They also employ technology for security and signal clarity.

The two output relays are also configurable depending on your needs.

## Transmitters 433 MHz Transmitter Family

DETAIL	DESCRIPTION	PART NUMBER
	Ultra-small 433 MHz Replacement	234475
	433 MHz One-channel Hand Held	234465
	433 MHz Two-channel Hand Held	234467
	433 MHz Four-channel Hand Held	234469
	433 MHz Two-channel Micro	234518

NOTE: Larco Ultra-Small transmitters are not compatible with any 300 MHz transmitter/receiver products.

Larco Ultra-small transmitters utilize full size cases to increase ease of use and are available in discrete one, two, and four channel varieties. A two-channel key fob size transmitter is ideal for pocket or key chain use also is available. Receivers are sold separately.

## 300 MHz Transmitter Family

DETAIL	DESCRIPTION	PART NUMBER
	300 MHz Replacement Transmitter	216546
	300 MHz One-channel Hand Held	214081
	300 MHz Two-channel Hand Held	216739
	300 MHz Four-channel Hand Held	216063
	300 MHz One-channel Micro	217710

# Finger Guards

## Safety Components for Automatic Doors

Larco finger guards provide added protection for your automatic door installation. The primary purpose of a finger guard is as a protective device. It limits the ability of the door to cause injury if fingers are inadvertently placed in the area between the door and frame. As an added benefit, finger guards act as a seal, isolating the interior and exterior environments when the door is closed.

### Finger Guard for Hinge-hung and Center Pivot Applications (84" long)

DESCRIPTION	PART NUMBER
5" Wide Assembly	0021098010
10" Wide Assembly	1021098010

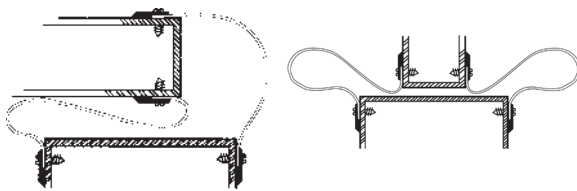

Door Detail

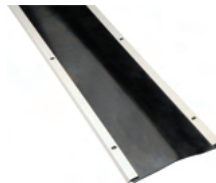

Hinge-hung applications use black rubberized fabric to span the gap between the doorframe and the door. Continuous perforated aluminum bars attached to both outside edges act as a clamp. Available in 5" and 10" widths; standard length is 84". Two assemblies are needed for each door leaf.

### Finger Guard for 1" Center-hung Applications (96" long)

DESCRIPTION	PART NUMBER
Complete Assembly	0021269900
Replacement Vinyl Insert	0021268901

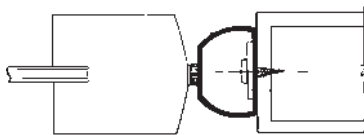

Door Detail



Center-hung applications use a black vinyl "D" shaped insert and a continuous perforated aluminum bar, which acts as a clamp. Standard length for center hung finger guards is 96". One assembly is needed for each door leaf.

# Automatic Door Products Product List



The power of control. Automated.

## DISTRIBUTED BY

--

220-0005-000 Rev. D 12/23

ATEK Access Technologies  
210 10th Ave. NE  
Brainerd, MN 56401 U.S.A.

PH: 1.800.523.6996  
FAX: 1.800.589.3705  
+1.218.829.9797

[www.atekaccess.com](http://www.atekaccess.com)



Access the power of technology.

©2023 ATEK Access Technologies, LLC. All Rights Reserved. Larco images and marketing materials are protected by various patents, copyrights and/or trademarks. ATEK assumes no responsibility for any errors which may appear in this document, reserves the right to change devices or specifications detailed herein at any time without notice, and does not make any commitment to update the information contained herein. No licenses to patents or other intellectual property of ATEK are granted by the Company in connection with the sale of Larco products, expressly or by implication.